

Knobs &
handles
catalogue

2024

viefe.com

Made to

STAND
OUT

Viefe[®]

20
24

Viefe[®]



**Handles & knobs
catalogue**

 **viefe.com**

MADE TO STAND OUT

eng

A charismatic personality

The personality of our collection of knobs and handles for 2024 stands out for many different reasons: for their daring character; for their creative rebelliousness; and for shaking the foundations of everything that we have designed until now. It's a new beginning.

We have maximized features and aesthetics. The handles with larger dimensions have become more forceful with big diameters which allow them to be used in new ways thanks to the “back to back” format which means they can be fitted on both sides of the door. They stand out for their natural look which is why we created them. The organic spirit of wood can be found in the details which make the difference, whilst the new finishes flood your interiors with a special charisma. All of our designs are really surprising as they are full of freedom.

esp

Personalidad carismática

La personalidad de nuestra nueva colección de pomos y tiradores 2024 destaca por muchos motivos: por su carácter atrevido; por su rebeldía creativa; y por sacudir los cimientos de todo lo que hemos diseñado hasta ahora. Es un punto y aparte.

Estética y prestaciones se maximizan. Los tiradores de grandes dimensiones aumentan su contundencia con diámetros “big” y permiten nuevas formas de uso gracias al formato “back to back” que hace posible instalarlos a ambos lados de las puertas. Sobresalen con naturalidad, forma parte de su esencia.

El espíritu orgánico de la madera se propaga en detalles que marcan la diferencia, mientras nuevos acabados inundan los interiorismos de un carisma especial. Todos los diseños sorprenden, porque están llenos de libertad.

cat

Personalitat carismàtica

La personalitat de la nostra nova col·lecció de pomos i agafadors 2024 destaca per molts motius: pel seu caràcter agosarat; per la seva rebel·lia creativa; i per sacsejar els fonaments de tot el que hem dissenyat fins ara. És un punt i apart.

Estètica i prestacions es maximitzen. El agafadors de grans dimensions augmenten la seva contundència amb diàmetres “big” i permeten noves formes d'ús gràcies al format “back to back” que fa possible instal·lar-los a banda i banda de les portes. Sobresurten amb naturalitat, els creem per això.

L'esperit orgànic de la fusta es propaga en detalls que marquen la diferència mentre nous acabats inunden els interiorismes d'un carisma especial. Tots els dissenys sorprenden, perquè estan plens de llibertat.



FROM VIEEFE *around the world*

eng ———

Singular products for plural tastes

Interior design professionals and architects from all around the world trust in our products for their projects, and of course individual customers. At Viefefe they can find a wide variety of eclectic, decorative accessories which adapt to different tastes and lifestyles. Our designs transform all types of spaces and transmit the personality of whoever lives in that space.

esp ———

Productos singulares para gustos plurales

Profesionales del interiorismo y la arquitectura de todo el mundo confían en nuestros productos para sus proyectos. Y también particulares, por supuesto. En Viefefe encuentran una amplia variedad de complementos decorativos eclécticos que se adaptan a los diferentes gustos y estilos de vida. Nuestros diseños transforman todo tipo de espacios y transmiten la personalidad de quienes los habitan.

cat ———

Productes singulars per a gustos plurals

Professionals de l'interiorisme i l'arquitectura de tot el món confien en els nostres productes per als seus projectes. I també particulars, és clar. A Viefefe hi ha una àmplia varietat de complementos decoratius eclèctics que s'adapten als diferents gustos i estils de vida. Els nostres dissenys transformen tota mena d'espais i transmeten la personalitat dels qui hi habiten.

OUT STANDING *Designers*

eng _____

Challenging the conventional

We have the privilege of designing in Europe, collaborating with designers from all over the world who help us to go that little step further. Together we explore new horizons in decorative accessories. We make a fusion of shapes, materials and trends. We challenge the conventional to create the unexpected.

esp _____

Desafiamos lo convencional

Tenemos el privilegio de diseñar desde Europa en colaboración con diseñadores de todo el mundo que nos llevan a ir un paso más allá. Juntos exploramos nuevos horizontes en accesorios decorativos. Fusionamos formas, materiales y tendencias. Desafiamos lo convencional para crear lo inesperado.

cat _____

Desafiem el que és convencional

Tenim el privilegi de dissenyar des d'Europa en col·laboració amb dissenyadors de tot el món que ens porten a anar un pas més enllà. Junts explorem nous horitzons en accessoris decoratius. Fusionem formes, materials i tendències. Desafiem el que és convencional per crear l'inesperat.

ALEXIS VIVET / Spain
BALUTTO ASSOCIATI / Italy
FRANK PERSON / Germany
HÉCTOR DIEGO / Spain
ILJA HUBER / Germany
KASCHKASCH / Germany
PATRICIA ROIG / Spain
TERUEL-PARÉ / Spain
VIEFE STUDIO / Spain
2J DESIGN / USA

we love NATURE

eng —

Going for green

Each and every year we make further advances towards being more sustainable. The presence of wood in our products is ever increasing, we can certify its origins, as with the rest of our materials. The majority of our packaging is paper based and we have significantly reduced our use of non-recycled plastics. What's more, we are now working with 100% renewable energy and we also have the ISO 14001 certificate. We are taking action so that the natural environment that surrounds us tomorrow is just as green as that which surrounds us today.

esp —

Apostamos por lo verde

Cada año avanzamos para ser más sostenibles. La presencia de la madera en nuestros productos es cada vez mayor, podemos certificar su origen y también el del resto de materiales. Utilizamos packaging mayoritariamente de papel y hemos reducido al máximo los plásticos no reciclados. Además, funcionamos 100% con energías renovables y disponemos de la ISO 14001. Actuamos para que el entorno natural que nos rodee mañana sea tan verde como el de hoy.

cat —

Apostem pel verd

Cada any avancem per ser més sostenibles. La presència de la fusta als nostres productes és cada vegada més gran, podem certificar-ne l'origen i també el de la resta de materials. Utilitzem packaging majoritàriament de paper i hem reduït al màxim els plàstics no reciclats. A més, funcionem 100% amb energies renovables i disposem de la ISO 14001. Actuem perquè l'entorn natural que ens envolti demà sigui tan verd com el d'avui.

—
This is our HOME

Viefe[®]

OUR *Products*

**Nuestros
productos**

**Els nostres
productes**



0636

POINT

ALUMINIUM

Designer: Patricia Roig

NEW!

Finishes

Acabados

Brushed black
Negro cepillado

Titanium black
Negro titanio

Brushed brass cava
Latón cava cepillado

←→ | o — o 1 o — o 2

| | | | |
|---------|--------|-------|---|
| Ø 40 mm | - | - | |
| 110 mm | - | - | Includes non-twisting tip / <i>Incluye punta anti-giro</i> |
| 228 mm | 192 mm | - | |
| 356 mm | 320 mm | - | |
| 996 mm | 960 mm | 480mm | |



Technical info on page 288
Info técnica en pág 288





0636

POINT

ALUMINIUM

Designer: Patricia Roig

NEW!





0627

FUSION

ZAMAK

Designer: Ilja Huber

NEW!

Finishes
Acabados

Titanium black
Negro titanio

Brushed brass cava
Latón cava cepillado

Matt black
Negro mate



| | | |
|--------|--------|--|
| ←→ | o — o | |
| 58 mm | - | |
| 180 mm | 160 mm | |
| 340 mm | 320 mm | |

Includes non-twisting tip
Incluye punta anti-giro



Technical info on page 288
Info técnica en pág 288



0627

FUSION

ZAMAK

Designer: Ilja Huber

NEW!



| | |
|--------|--------|
| ←→ | o — o |
| 58 mm | - |
| 180 mm | 160 mm |
| 340 mm | 320 mm |

Includes non-twisting tip
Incluye punta anti-giro

Finishes *Acabados*

Polished titanium black
Titanio negro brillo

Polished nickel
Níquel brillo

Polished brass
Latón brillo



Technical info on page 288
Info técnica en pág 288



0635

LIDD

ZAMAK

Designer: Ilja Huber

NEW!

Finishes
Acabados

Brushed nickel
Níquel cepillado

Titanium black
Negro titanio

Brushed brass cava
Latón cava cepillado

Matt white
Blanco mate

Matt black
Negro mate

∅
64 mm



⊕
Technical info on page 289
Info técnica en pág 289



0638

PRISM

ZAMAK

Designer: Patricia Roig

NEW!



Finishes
Acabados

Titanium black
Negro titanio

Brushed brass cava
Latón cava cepillado

Matt white
Blanco mate

Matt black
Negro mate

Polished titanium black
Titanio negro brillo

Polished nickel
Níquel brillo

Polished brass
Latón brillo



32 mm

Includes non-twisting tip
Incluye punta anti-giro



Technical info on page 289
Info técnica en pág 289



0643

LINKK

ALUMINIUM

Designer: Alexis Vivet

NEW!

Finishes
Acabados

Stainless steel look
Inox look

Brushed brass
Latón cepillado

Brushed black
Negro cepillado

| ←→ | o — o 1 | o — o 2 |
|---------|---------|---------|
| 175 mm | 160 mm | - |
| 335 mm | 320 mm | - |
| 1071 mm | 1056 mm | 528 mm |

⊕
Technical info on page 290
Info técnica en pág 290



0643

LINKK

ALUMINIUM

Designer: Alexis Vivet

NEW!





0648

OMEGA

ZAMAK

Designer: Kaschkasch

NEW!

Finishes
Acabados

Brushed brass cava
Latón cava cepillado

Rustic brass
Latón rústico

Matt black
Negro mate



| | |
|----------|--------|
| ←→ | ○ — ○ |
| 62,5 mm | 32 mm |
| 190,5 mm | 160 mm |

⊕
Technical info on page 290
Info técnica en pág 290



0650

MOULE

ZAMAK

Designer: Kaschkasch

NEW!

Finishes

Acabados

Titanium black
Negro titanio

Brushed brass cava
Latón cava cepillado

Matt white
Blanco mate

Matt black
Negro mate



154 mm

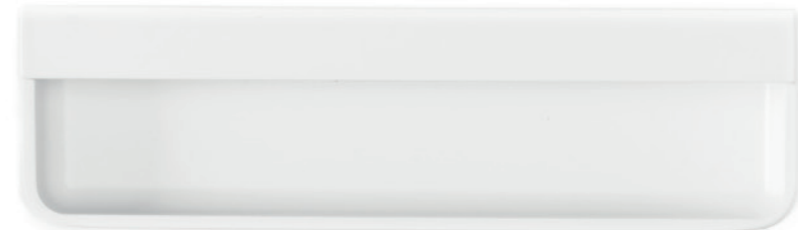

Technical info on page 291
Info técnica en pág 291



0603

LIPP

ZAMAK

Designer: Alexis Vivet

NEW!



Finishes
Acabados

Brushed brass cava
Latón cava cepillado

Matt black
Negro mate

| | |
|--------|--------|
| ←→ | o — o |
| 205 mm | 192 mm |
| 333 mm | 320 mm |

⊕
Technical info on page 291
Info técnica en pág 291



0645

RISS mini

ALUMINIUM

Designer: Kaschkasch

NEW!

Finishes
Acabados

Matt white
Blanco mate

Matt black
Negro mate

Moss grey
Gris musgo

Forest green
Verde forest

Mocca brown
Marrón mocca

Volcano red
Rojo volcano

Midnight blue
Azul midnight



Technical info on page 292
Info técnica en pág 292

| ←→ | o — o | ∅ |
|--------|--------|-------|
| 207 mm | 192 mm | 15 mm |
| 335 mm | 320 mm | 15 mm |





0655

RISS big

ALUMINIUM

Designer: Kaschkasch

NEW!

Finishes Acabados

Matt white
Blanco mate

Matt black
Negro mate

Moss grey
Gris musgo

Forest green
Verde forest

Mocca brown
Marrón mocca

Volcano red
Rojo volcano

Midnight blue
Azul midnight



| ←→ | o — o 1 | o — o 2 | ∅ |
|--------|---------|---------|-------|
| 502 mm | 480 mm | - | 20 mm |
| 982 mm | 960 mm | 480 mm | 20 mm |



Technical info on page 292
Info técnica en pág 292



0657

NOBB

ALUMINIUM

Designer: Viefe Studio

NEW!

| ←→ | o — o 1 | o — o 2 | |
|---------|---------|---------|--|
| 52 mm | - | - | Includes non-twisting tip / Incluye punta anti-giro |
| 244 mm | 192 mm | - | |
| 372 mm | 320 mm | - | |
| 1108 mm | 1056 mm | 528mm | |

Finishes
Acabados

Stainless steel look
Inox look

Brushed brass cava
Latón cava cepillado

Brushed black
Negro cepillado



Technical info on page 293
Info técnica en pág 293

0657

NOBB

ALUMINIUM

Designer: Viefe Studio

NEW!

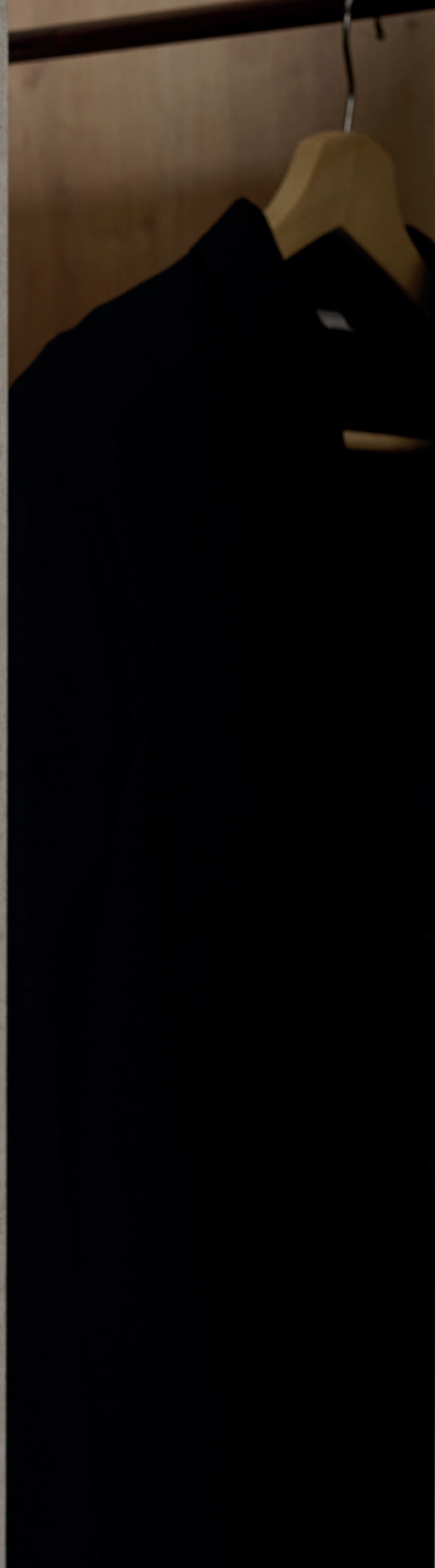

0629 / 0662 / 0663

MOON

ALUMINIUM

Designer: Ilja Huber

NEW!

Finishes
Acabados

Stainless steel look
Inox look

Brushed brass cava
Laton cava cepillado

Brushed black
Negro cepillado



|  |  |  |
|---|---|---|
| 424 mm | 384 mm | - |
| 1096 mm | 1056 mm | 528 mm |

 Available with one side system
Disponible con sistema de una cara

 Available with back to back system
Disponible con sistema de doble cara

 Technical info on page 293
Info técnica en pág 293

0629 / 0662 / 0663

MOON

ALUMINIUM

Designer: Ilja Huber

NEW!





0658

DUO mini

ALUMINIUM + WOOD

Designer: Ilja Huber

NEW!



Finishes Acabados

- Lava grey + Oak
 Gris lava + Roble
- Lava grey + Walnut
 Gris lava + Nogal
- Matt black +
 Oak matt black lacquered
 Negro mate +
 Roble lacado negro mate

| K → | o — o |
|----------|--------|
| 194,6 mm | 160 mm |
| 354,6 mm | 320 mm |

Certified wood
 Madera certificada

Technical info on page 294
 Info técnica en pág 294

0659 / 0668 / 0670

DUO big

ALUMINIUM + WOOD

Designer: Ilja Huber

NEW!

Finishes Acabados

- 🌿 Lava grey + Oak
Gris lava + Roble
- Lava grey + Walnut
Gris lava + Nogal
- 🌿 Matt black +
Oak matt black lacquered
*Negro mate +
Roble lacado negro mate*

| ←→ | o — o 1 | o — o 2 |
|---------|---------|---------|
| 536 mm | 480 mm | - |
| 1016 mm | 960 mm | 480 mm |



Certified wood
Madera certificada



Available with one side system
Disponible con sistema de una cara



Available with back to back system
Disponible con sistema de doble cara



Technical info on page 294
Info técnica en pág 294

0664 / 0665 / 0671

LUV WOOD

WOOD

Designer: Kaschkasch

NEW!

Finishes Acabados

- 🌿 Oak
Roble
- Walnut
Nogal
- 🌿 Oak matt black lacquered
Roble lacado negro mate

| ←→ | o — o 1 | o — o 2 |
|-----------|---------|---------|
| 418,5 mm | 384 mm | - |
| 1026,5 mm | 992 mm | 496 mm |



🌿 Certified wood
Madera certificada

ⓘ Available with one side system
Disponible con sistema de una cara

Ⓜ Available with back to back system
Disponible con sistema de doble cara

⊕ Technical info on page 295
Info técnica en pág 295

0664 / 0665 / 0671

LUV WOOD

WOOD

Designer: Kaschkasch

NEW!





0536

LUV

ZAMAK

Designer: Kaschkasch

Finishes
Acabados

| | ←→ | o — o | |
|---|---------|--------|---|
| Brushed nickel <i>Níquel cepillado</i> | 51,2 mm | - | Includes non-twisting tip <i>Incluye punta anti-giro</i> |
| Brushed brass cava <i>Latón cava cepillado</i> | 202 mm | 192 mm | |
| | 330 mm | 320 mm | |

Matt white
Bianco mate

Matt black
Negro mate



Technical info on page 295
Info técnica en pág 295



0621

RILLE mini ALUMINIUM

Designer: Patricia Roig

NEW!

Finishes
Acabados

Polished nickel
Níquel brillo

Stainless steel look
Inox look

Brushed brass
Latón cepillado

Brushed black
Negro cepillado

| ←→ | o — o |
|--------|--------|
| 55 mm | - |
| 190 mm | 160 mm |
| 350 mm | 320 mm |

Includes non-twisting tip
Incluye punta anti-giro



Technical info on page 296
Info técnica en pág 296



0528

RILLE

ALUMINIUM

Designer: Patricia Roig



Finishes
Acabados

- Stainless steel look
Inox look
- Brushed brass
Latón cepillado
- Brushed black
Negro cepillado



| ←→ | o — o 1 | o — o 2 | |
|---------|---------|---------|---|
| 55 mm | - | - | Includes non-twisting tip <i>Incluye punta anti-giro</i> |
| 190 mm | 160 mm | - | |
| 350 mm | 320 mm | - | |
| 510 mm | 480 mm | - | |
| 1022 mm | 992 mm | 496 mm | |

⊕
Technical info on page 296
Info técnica en pág 296



0487

PURA

ZAMAK

Designer: Balutto Associati

Finishes
Acabados

Polished chrome
Cromo brillo

Polished titanium black
Titanio negro brillo

Polished copper
Cobre brillo

Polished brass
Latón brillo

NEW! Brushed nickel
Níquel cepillado

NEW! Brushed brass cava
Latón cava cepillado

NEW! Matt black
Negro mate

←→ | o — o

168 mm 160 mm

NEW! 264 mm 256 mm

⊕
Technical info on page 297
Info técnica en pág 297

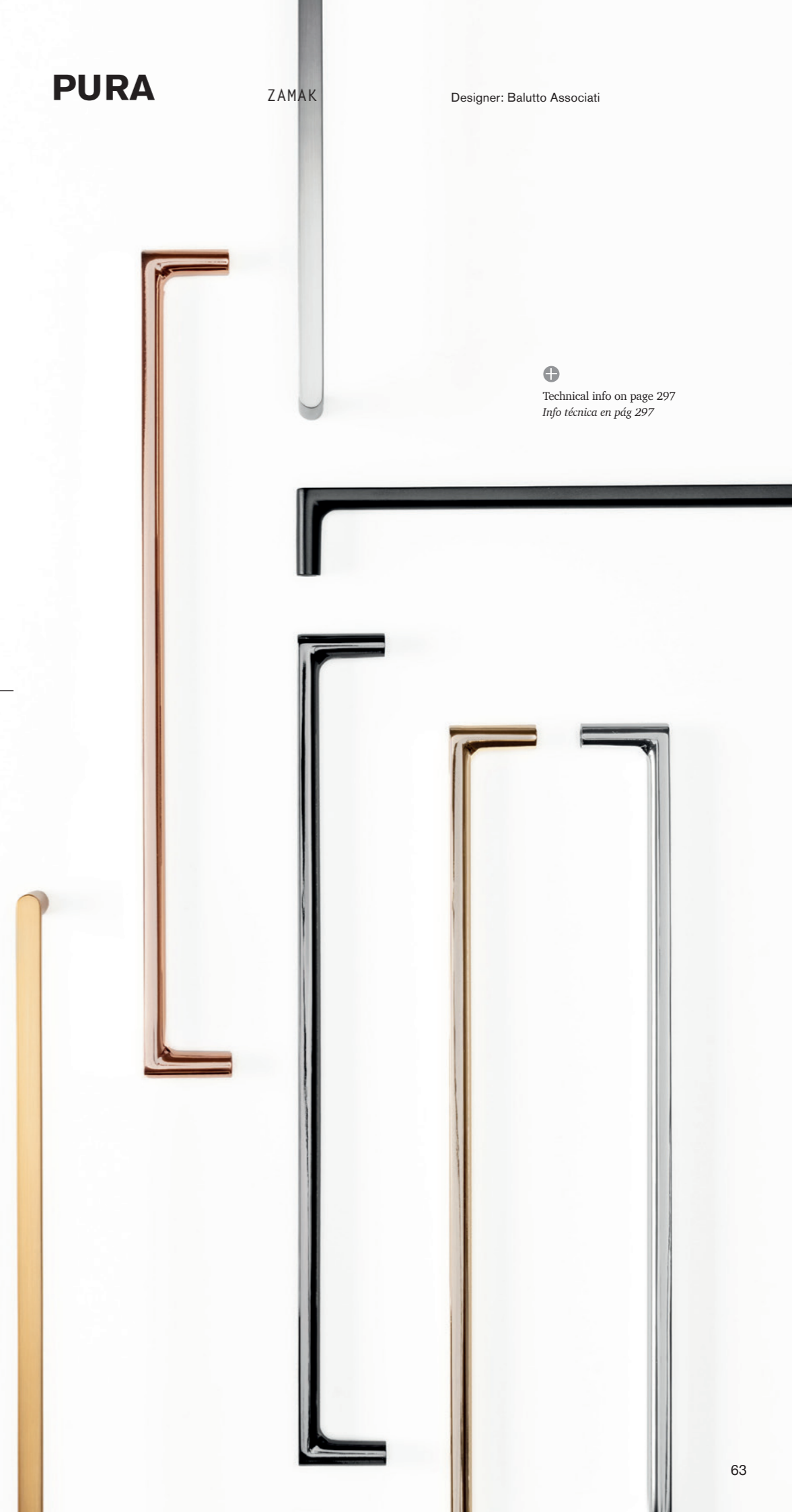



0487

PURA

ZAMAK

Designer: Balutto Associati





0590

BELT

ZAMAK

Designer: Kaschkasch



Finishes Acabados

Matt white
Blanco mate

Matt black
Negro mate

Moss grey
Gris musgo

Forest green
Verde forest

Mocca brown
Marrón mocca

Volcano red
Rojo volcan

| | | |
|----------|--------|---|
| ←→ | o — o | Includes non-twisting tip <i>Incluye punta anti-giro</i> |
| 63,5 mm | - | |
| 221,3 mm | 160 mm | |

⊕
Technical info on page 297
Info técnica en pág 297



0590

BELT

ZAMAK

Designer: Kaschkasch

Finishes
Acabados

Matt white
Blanco mate

Matt black
Negro mate

Moss grey
Gris musgo

Forest green
Verde forest

Mocca brown
Marrón mocca

Volcano red
Rojo volcano

| | | |
|---|---|---|
| $\leftarrow \rightarrow$ 63,5 mm 221,3 mm | $\circ \text{---} \circ$ - 160 mm | Includes non-twisting tip <i>Incluye punta anti-giro</i> |
|---|---|---|



⊕
 Technical info on page 297
Info técnica en pág 297



0597

PLIÉ

ZAMAK

Designer: Teruel & Paré

Finishes
Acabados

Matt black
Negro mate

Metal grey
Gris metal

Metal brown
Marrón metal

| | |
|--------|--------|
| ◀—▶ | ○ — ○ |
| 114 mm | 64 mm |
| 210 mm | 160 mm |



⊕
Technical info on page 298
Info técnica en pág 298



0600

WING

ALUMINIUM

Designer: Alexis Vivet

Finishes

Acabados

Stainless steel look
Inox look

Brushed black
Negro cepillado

Antique bronze
Bronce antiguo

Brushed brass cava
Latón cava cepillado

|<—>|

o — o 1

o — o 2

100 mm

64 mm

-

200 mm

128 mm

-

350 mm

256 mm

-

1200 mm

1120 mm

384 mm



Technical info on page 298
Info técnica en pág. 298

0600

WING

ALUMINIUM

Designer: Alexis Vivet





0610

FLAPP

ALUMINIUM

Designer: Frank Person

Finishes
Acabados

| | ←→ | o — o 1 | o — o 2 |
|---|---------|---------|---------|
| Stainless steel look <i>Inox look</i> | 70 mm | 32 mm | - |
| Brushed black <i>Negro cepillado</i> | 200 mm | 128 mm | 160 mm |
| Brushed brass cava <i>Latón cava cepillado</i> | 350 mm | 256 mm | - |
| | 1100 mm | 416 mm | 1056 mm |

⊕
Technical info on page 299
Info técnica en pág 299



0610

FLAPP

ALUMINIUM

Designer: Frank Person





0613

FLAPP

WOOD

Designer: Frank Person



Finishes
Acabados

Oak
Roble

Walnut
Nogal

Oak raw
Roble crudo

| ←→ | o — o 1 | o — o 2 |
|---------|---------|---------|
| 70 mm | 32 mm | - |
| 200 mm | 160 mm | - |
| 1100 mm | 1056 mm | 416 mm |



Technical info on page 300
Info técnica en pág. 300





0613

FLAPP

WOOD

Designer: Frank Person





0591

ETO

ALUMINIUM + WOOD

Designer: Kaschkasch



Technical info on page 299
 Info técnica en pág 299



Finishes
Acabados

Lava grey + Oak
 Gris lava + roble

Lava grey + Walnut
 Gris lava + Nogal

Matt black + Ash matt black lacquered
 Negro mate + Fresno lacado negro mate

| ←→ | o — o 1 | o — o 2 |
|-----------|---------|---------|
| 174,6 mm | 160 mm | - |
| 334,6 mm | 320 mm | - |
| 1006,6 mm | 992 mm | 496 mm |



0591

ETO

ALUMINIUM + WOOD

Designer: Kaschkasch





0601

OH!

WOOD

Designer: Alexis Vivet

Finishes
Acabados

Oak
Roble

Walnut
Nogal

Ash matt black lacquered
Fresno lacado negro mate



40 mm



Technical info on page 300
Info técnica en pág. 300



0601

OH!

ZAMAK

Designer: Alexis Vivet

Finishes

Acabados

Brushed nickel
Níquel cepillado

Brushed brass cava
Latón cava cepillado

Matt black
Negro mate



40 mm



Technical info on page 301
Info técnica en pág. 301



0602

VALLEY

ZAMAK

Designer: Alexis Vivet

Finishes

Acabados

Polished titanium black
Titanio negro brillo

Polished brass
Latón brillo

Matt black
Negro mate

Brushed brass cava
Latón cava cepillado

| | |
|--------|--------|
| K → I | o — o |
| 223 mm | 160 mm |
| 330 mm | 256 mm |



⊕
Technical info on page 301
Info técnica en pág. 301



0602

VALLEY

ZAMAK

Designer: Alexis Vivet



Finishes
Acabados

Polished titanium black
Titanio negro brillo

Polished brass
Latón brillo

Matt black
Negro mate

Brushed brass cava
Latón cava cepillado

| | |
|--------|--------|
| ←→ | ○ — ○ |
| 223 mm | 160 mm |
| 330 mm | 256 mm |

⊕
Technical info on page 301
Info técnica en pág. 301



0614

EQUIS

ZAMAK

Designer: Patricia Roig



Finishes
Acabados

Polished chrome
Cromo brillo

Polished titanium black
Titanio negro brillo

Polished copper
Cobre brillo

Polished brass
Latón brillo

Matt white
Blanco mate

Matt black
Negro mate



40 mm



Technical info on page 302
Info técnica en pág 302



0604

PRISMA

ZAMAK

Designer: Alexis Vivet



Finishes
Acabados

Matt black
Negro mate

Rustic brass
Latón rústico

| | | |
|--------|--------|---|
| ←→ | o — o | |
| 78 mm | - | Includes non-twisting tip <i>Incluye punta anti-giro</i> |
| 272 mm | 192 mm | |



Technical info on page 301
Info técnica en pág 301



0608

QUART mini

ZAMAK

Designer: Frank Person

Finishes
Acabados

Brushed brass cava
Latón cava cepillado

Rustic brass
Latón rústico

Matt black
Negro mate

| | | |
|--------|--------|---|
| ←→ | o — o | |
| 26 mm | - | Includes non-twisting tip <i>Incluye punta anti-giro</i> |
| 146 mm | 128 mm | |



⊕
Technical info on page 302
Info técnica en pág. 302



0616

QUART big

ZAMAK

Designer: Frank Person



Finishes Acabados

Brushed brass cava
Latón cava cepillado

Rustic brass
Latón rústico

Matt black
Negro mate

| | | |
|----------|--------|---|
| ←→ | o — o | Includes non-twisting tip <i>Incluye punta anti-giro</i> |
| 33,8 mm | - | |
| 183,4 mm | 160 mm | |

⊕
Technical info on page 302
Info técnica en pág 302



0588

ARPA PLATE

ALUMINIUM

Designer: Viefe Studio

Finishes
Acabados

Rustic brass
Latón rústico

| | |
|---------|--------|
| ←→ | o — o |
| Ø 22 mm | |
| 70 mm | - |
| 230 mm | 192 mm |



⊕
Technical info on page 306
Info técnica en pág 306

0588

ARPA PLATE

ALUMINIUM

Designer: Viefe Studio

Finishes

Acabados

| | ←→ | o — o 1 | o — o 2 |
|--|---------|---------|---------|
| Stainless steel look <i>Inox look</i> | Ø 22 mm | - | - |
| | 70 mm | - | - |
| Brushed brass <i>Latón cepillado</i> | 230 mm | 192 mm | - |
| | 358 mm | 320 mm | - |
| Brushed black <i>Negro cepillado</i> | 1216 mm | 1178 mm | 589 mm |



Technical info on page 306
Info técnica en pág 306

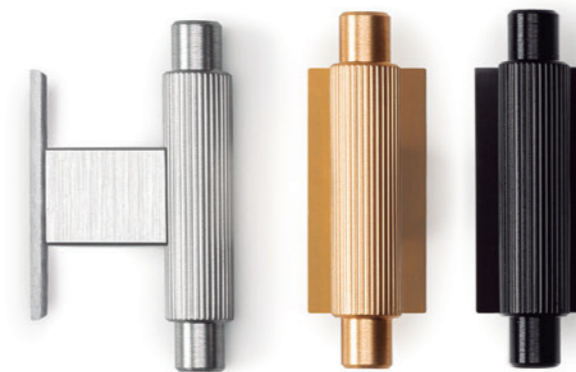



0583

ARPA

ALUMINIUM

Designer: Viefe Studio

Finishes
Acabados

Rustic brass
Latón rústico

↳ | ◦ — ◦

Ø 22 mm -

70 mm -

214 mm

- Includes non-twisting tip
Incluye punta anti-giro



⊕
Technical info on page 307
Info técnica en pág 307



0583

ARPA

ALUMINIUM

Designer: Viefe Studio

Finishes
Acabados

Stainless steel look
Inox look

Brushed brass
Latón cepillado

Brushed black
Negro cepillado

| ←→ | o — o 1 | o — o 2 | |
|---------|---------|---------|---|
| Ø 22 mm | - | - | |
| 70 mm | - | - | Includes non-twisting tip <i>Incluye punta anti-giro</i> |
| 214 mm | 192 mm | - | |
| 342 mm | 320 mm | - | |
| 1200 mm | 1178 mm | 589 mm | |



⊕
Technical info on page 307
Info técnica en pág 307

0583

ARPA

ALUMINIUM

Designer: Viefe Studio





0506

FIRM

ZAMAK

Designer: Frank Person



Finishes
Acabados

Textured black
Negro texturizado

←→ | o — o

45,8 mm -

93,8 mm 64 mm

93,8 mm 64 mm *Cup pull / Tirador concha*

125,8 mm 96 mm

189,8 mm 160 mm

349,8 mm 320 mm



Technical info on page 315
Info técnica en pág 315



0506

FIRM

ZAMAK

Designer: Frank Person



0506

FIRM

ZAMAK

Designer: Frank Person

Finishes
Acabados

Textured black
Negro texturizado

| ←→ | o — o |
|----------|--|
| 45,8 mm | - |
| 93,8 mm | 64 mm |
| 93,8 mm | 64 mm <i>Cup pull / Tirador concha</i> |
| 125,8 mm | 96 mm |
| 189,8 mm | 160 mm |
| 349,8 mm | 320 mm |



⊕
Technical info on page 315
Info técnica en pág 315



0530

DISC

WOOD

Designer: Balutto Associati



Finishes
Acabados

Oak
Roble

Walnut
Nogal

Ash matt black lacquered
Fresno lacado negro mate



38 mm
50 mm



Technical info on page 303
Info técnica en pág. 303



0530

DISC

ZAMAK

Designer: Balutto Associati



Finishes
Acabados

Brushed nickel
Níquel cepillado

Brushed brass cava
Latón cava cepillado

Matt white
Blanco mate

Matt black
Negro mate



38 mm
50 mm



Technical info on page 303
Info técnica en pág. 303



0538

CONIC

WOOD

Designer: Kaschkasch



Finishes
Acabados

Oak
Roble

Walnut
Nogal

Ash matt black lacquered
Fresno lacado negro mate



29,4 mm

43 mm



Technical info on page 303
Info técnica en pág. 303



0538

CONIC

ZAMAK

Designer: Kaschkasch



**Finishes
Acabados**

Matt white
Blanco mate

Matt black
Negro mate

Moss grey
Gris musgo



29,4 mm

43 mm



Technical info on page 304
Info técnica en pág. 304



0542

FOLD

ZAMAK

Designer: Teruel & Paré

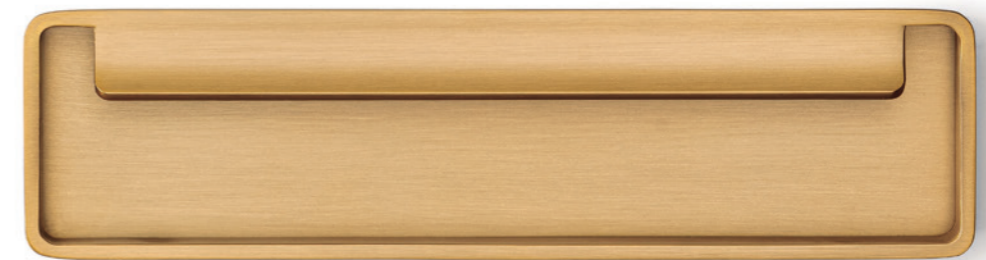
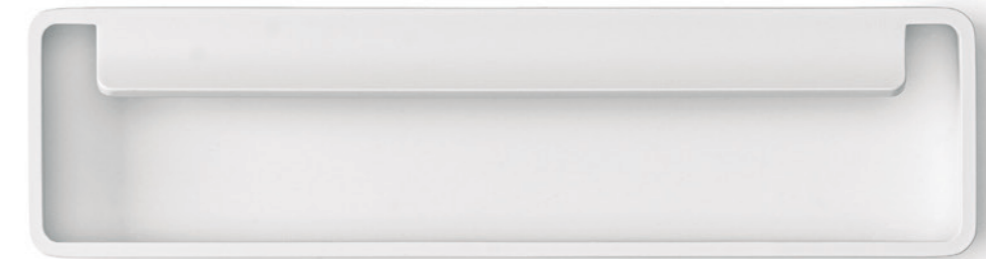

Finishes
Acabados

Brushed nickel
Níquel cepillado

Brushed brass cava
Latón cava cepillado

Matt white
Blanco mate

Matt black
Negro mate

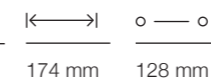

⊕
Technical info on page 306
Info técnica en pág 306

0542

FOLD

ZAMAK

Designer: Teruel & Paré



Finishes
Acabados

Brushed nickel
Níquel cepillado

Brushed brass cava
Latón cava cepillado

Matt white
Blanco mate

Matt black
Negro mate

←→ | o — o
174 mm | 128 mm

⊕
Technical info on page 306
Info técnica en pág 306



0543

SOFT

ZAMAK

Designer: Uli Budde



Finishes
Acabados

| | ←→ | o — o |
|----------------------------------|--------|--------|
| Matt white <i>Blanco mate</i> | 40 mm | 32 mm |
| Matt black <i>Negro mate</i> | 200 mm | 192 mm |
| Moss grey <i>Gris musgo</i> | 328 mm | 320 mm |

⊕
Technical info on page 304
Info técnica en pág 304



0552

RIM

ZAMAK

Designer: Bernat Lluch

Finishes
Acabados

Brushed nickel
Níquel cepillado

Brushed brass cava
Latón cava cepillado

Matt white
Blanco mate

Matt black
Negro mate

Moss grey
Gris musgo

←→ | ○ — ○
120 mm | 96 mm

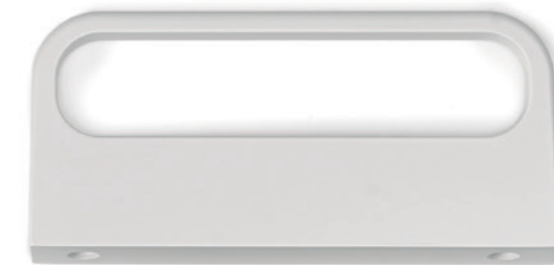

Technical info on page 305
Info técnica en pág 305



0553

OTO

ZAMAK

Designer: Bernat Lluch



Finishes
Acabados

Black textured
Negro texturizado

| | |
|--------|--------|
| ←→ | o — o |
| 60 mm | - |
| 168 mm | 128 mm |

⊕
Technical info on page 305
Info técnica en pág. 305



0556

DIPO

ZAMAK

Designer: Bernat Lluch



Finishes
Acabados

Matt white
Blanco mate

Matt black
Negro mate

Moss grey
Gris musgo



74 mm



Technical info on page 304
Info técnica en pág. 304



0372

ONA

ALUMINIUM

Designer: Teruel & Paré

Finishes
Acabados

Stainless steel look
Inox look

Brushed dark brass
Latón cepillado oscuro

Brushed black
Negro cepillado

Brushed grey
Gris cepillado

Matt white
Blanco mate

Metallic grey
Gris metal

Metallic brown
Marrón metal



| ←→ | o — o 1 | o — o 2 |
|---------|---------|---------|
| 50 mm | 32 mm | - |
| 200 mm | 128 mm | - |
| 350 mm | 256 mm | - |
| 600 mm | 544 mm | - |
| 1100 mm | 1056 mm | 416 mm |
| 1500 mm | 1440 mm | 480 mm |



Technical info on page 326
Info técnica en pág. 326



0372

ONA

ALUMINIUM

Designer: Teruel & Paré



Finishes
Acabados

- Stainless steel look
Inox look
- Brushed dark brass
Latón cepillado oscuro
- Brushed black
Negro cepillado
- Brushed grey
Gris cepillado
- Matt white
Blanco mate
- Metallic grey
Gris metal
- Metallic brown
Marrón metal

| ←→ | ○ — ○ 1 | ○ — ○ 2 |
|---------|---------|---------|
| 50 mm | 32 mm | - |
| 200 mm | 128 mm | - |
| 350 mm | 256 mm | - |
| 600 mm | 544 mm | - |
| 1100 mm | 1056 mm | 416 mm |
| 1500 mm | 1440 mm | 480 mm |

⊕
Technical info on page 326
Info técnica en pág 326

0254 / 0255

NOMA

ALUMINIUM

Designer: 2J Design



Finishes
Acabados

Anodized bright
Anodizado brillo

Stainless steel look
Inox look

Brushed black
Negro cepillado

Antique bronze
Bronce antiguo

Brushed brass cava
Latón cava cepillado

| | |
|--------|--------|
| ←→ | o — o |
| 200 mm | 128 mm |
| 350 mm | 256 mm |

⊕
Technical info on page 328
Info técnica en pág 328



Finishes Acabados

Polished chrome
Cromo brillo

Anodized matt
Anodizado mate

Stainless steel look
Inox look

Brushed dark brass
Latón oscuro cepillado

Matt White
Bianco mate

Matt black
Negro mate

Metallic grey
Gris metal

Metallic brown
Marrón metal

←→ | o — o

45 mm Consult technical info
90 mm Consultar info técnica

100 mm

120 mm

150 mm

190 mm

200 mm

250 mm

300 mm

400 mm

500 mm

600 mm

900 mm

1480 mm



Technical info on page 323
Info técnica en pág 323

0077

ANGLE

ALUMINIUM

Designer: Viefe Studio





0495

FLOID

ZAMAK

Designer: Frank Person

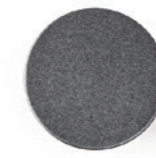

Finishes
Acabados

Brushed gold
Oro cepillado

Pewter
Peltre

Antique brass
Latón antiguo

Matt black
Negro mate

| ← → | o — o |
|----------|--------|
| Ø34,8 mm | - |
| 143,6 mm | 128 mm |
| 207,6 mm | 192 mm |

⊕
Technical info on page 308
Info técnica en pág 308



0496

BAU

ZAMAK

Designer: Patricia Roig



Finishes
Acabados

Brushed nickel
Níquel cepillado

Brushed gold
Oro cepillado

Matt black
Negro mate

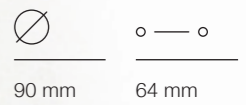

⊕
Technical info on page 308
Info técnica en pág 308

0127

JEY

ALUMINIUM

Designer: Viefe Studio



Finishes
Acabados

Stainless steel look
Inox look

Brushed brass cava
Latón cava cepillado

Matt white
Blanco mate

Matt black
Negro mate

←→|

147 mm
197 mm
247 mm
297 mm
347 mm
397 mm
447 mm
497 mm
597 mm
697 mm
797 mm
897 mm
997 mm
1197 mm
3000 mm*

* Available only in M1 and M2 finishes.
Three metre profiles are delivered according to the units of the original packaging and cannot be sold separately.

*Disponibile solo en los acabados M1 y M2.
Las barras de tres metros se sirven según las cantidades del embalaje original y no se pueden servir por separado.*

⊕
Technical info on page 309
Info técnica en pág 309



0127 JEY

0163 JEY2 (above)

ALUMINIUM

Designer: Viefe Studio

Finishes
Acabados

Stainless steel look
Inox look

Brushed brass cava
Latón cava cepillado

Matt white
Blanco mate

Matt black
Negro mate

←→|

147 mm
197 mm
247 mm
297 mm
347 mm
397 mm
447 mm
497 mm
597 mm
697 mm
797 mm
897 mm
997 mm
1197 mm
3000 mm*

* Available only in M1 and M2 finishes. Three metre profiles are delivered according to the units of the original packaging and cannot be sold separately.

Disponibile solo en los acabados M1 y M2. Las barras de tres metros se sirven según las cantidades del embalaje original y no se pueden servir por separado.



Technical info on page 309
Info técnica en pág 309



0168

COMO

ZAMAK

Designer: Viefe Studio



Finishes
Acabados

Polished chrome
Cromo brillo

Polished titanium black
Titanio negro brillo

Polished copper
Cobre brillo

Polished brass
Latón brillo



26 mm
41 mm



Technical info on page 310
Info técnica en pág 310



0168

COMO

ZAMAK

Designer: Viefe Studio

Finishes
Acabados

Matt chrome
Cromo mate

Brushed nickel
Níquel cepillado

Brushed copper
Cobre cepillado

Brushed gold
Oro cepillado

Matt black
Negro mate

Matt white
Blanco mate



26 mm
41 mm



Technical info on page 310
Info técnica en pág 310



0497

DIABOLO

ALUMINIUM

Designer: Frank Person



Finishes Acabados

Stainless steel look
Inox look

Brushed brass
Latón cepillado

Brushed black
Negro cepillado

Brushed grey
Gris cepillado



13,5 mm



Technical info on page 310
Info técnica en pág 310



0499

ROUND

ALUMINIUM

Designer: Balutto Associati



Finishes
Acabados

Stainless steel look
Inox look

Brushed brass
Latón cepillado

Brushed black
Negro cepillado



25 mm



Technical info on page 310
Info técnica en pág 310



0518

WAY

ALUMINIUM

Designer: Viefe Studio



Finishes
Acabados

| | ←→ | ○ — ○ 1 | ○ — ○ 1/2 | ○ — ○ 2 |
|---|---------|---------|-----------|---------|
| Anodized matt <i>Anodizado mate</i> | 50 mm | 32 mm | - | - |
| | 100 mm | 64 mm | - | - |
| Stainless steel look <i>Inox look</i> | 200 mm | 128 mm | - | - |
| | 400 mm | 320 mm | - | - |
| Brushed dark brass <i>Latón oscuro cepillado</i> | 800 mm | 736 mm | 368 mm | - |
| Matt White <i>Blanco mate</i> | 1100 mm | 1056 mm | - | 352 mm |
| Matt black <i>Negro mate</i> | | | | |

⊕
Technical info on page 311
Info técnica en pág 311

0518

WAY

ALUMINIUM

Designer: Viefe Studio



Finishes
Acabados

Anodized matt
Anodizado mate

Stainless steel look
Inox look

Brushed dark brass
Latón oscuro cepillado

Matt White
Blanco mate

Matt black
Negro mate

| ←→ | o — o 1 | o — o 1/2 | o — o 2 |
|---------|---------|-----------|---------|
| 50 mm | 32 mm | - | - |
| 100 mm | 64 mm | - | - |
| 200 mm | 128 mm | - | - |
| 400 mm | 320 mm | - | - |
| 800 mm | 736 mm | 368 mm | - |
| 1100 mm | 1056 mm | - | 352 mm |

⊕
Technical info on page 311
Info técnica en pág 311



0511

RAIL

ALUMINIUM

Designer: Teruel & Paré



Finishes
Acabados

Stainless steel look
Inox look

Brushed black
Negro cepillado

Brushed brass cava
Latón cava cepillado

| ←→ | o — o 1 | o — o 2 |
|-----------|---------|---------|
| 180 mm | 160 mm | - |
| 280 mm | 192 mm | - |
| 600 mm | 576 mm | 192 mm |
| * 1150 mm | 1120 mm | 192 mm |

* Off-center / *Descentrado*

⊕
Technical info on page 312
Info técnica en pág. 312



0511

RAIL

ALUMINIUM

Designer: Teruel & Paré



Finishes

Acabados

Stainless steel look
Inox look

Brushed black
Negro cepillado

Brushed brass cava
Latón cava cepillado

| ←→ | o — o 1 | o — o 2 |
|-----------|---------|---------|
| 180 mm | 160 mm | - |
| 280 mm | 192 mm | - |
| 600 mm | 576 mm | 192 mm |
| * 1150 mm | 1120 mm | 192 mm |

* Off-center / *Descentrado*



Technical info on page 312
Info técnica en pág 312



0056

U

ZAMAK

Designer: Viefe Studio



Finishes
Acabados

Matt white
Blanco mate

| ←→ | o — o |
|----------|--------|
| 136,5 mm | 128 mm |
| 168,5 mm | 160 mm |
| 200,5 mm | 192 mm |
| 328,5 mm | 320 mm |
| 500,5 mm | 492 mm |

⊕
Technical info on page 312
Info técnica en pág 312



0056

U

ZAMAK

Designer: Viefe Studio

Finishes
Acabados

| | ←→ | o — o |
|---|----------|--------|
| Polished chrome <i>Cromo brillo</i> | 136,5 mm | 128 mm |
| Matt chrome <i>Cromo mate</i> | 168,5 mm | 160 mm |
| Matt nickel <i>Niquel cepillado</i> | 200,5 mm | 192 mm |
| Brushed nickel <i>Niquel cepillado</i> | 328,5 mm | 320 mm |
| Matt black <i>Negro mate</i> | | |
| Brushed copper <i>Cobre cepillado</i> | | |
| Brushed brass <i>Latón cepillado</i> | | |
| Matt white <i>Blanco mate</i> | | |
| Brushed grey <i>Gris cepillado</i> | | |



⊕
Technical info on page 312
Info técnica en pág 312



0241

ROMA

ZAMAK

Designer: 2J Design



Finishes
Acabados

Polished chrome
Cromo brillo

Brushed nickel
Níquel cepillado

Brushed gold
Oro cepillado

Matt black
Negro mate

| ← → | o — o |
|--------|--------|
| 175 mm | 160 mm |
| 207 mm | 192 mm |
| 335 mm | 320 mm |

⊕
Technical info on page 313
Info técnica en pág 313



0241

ROMA

ZAMAK

Designer: 2J Design



Finishes
Acabados

Polished chrome
Cromo brillo

Brushed nickel
Níquel cepillado

Brushed gold
Oro cepillado

Matt black
Negro mate

←→ | o — o

175 mm 160 mm

207 mm 192 mm

335 mm 320 mm



Technical info on page 313
Info técnica en pág 313



0489

BOL

ZAMAK / WOOD

Designer: Balutto Associati

Finishes Acabados

Matt black + Sapelly
Negro mate + Sapelly

Matt black + Beech
Negro mate + Haya

Matt black + Matt white lacquered
Negro mate + Lacado blanco mate



45 mm



Technical info on page 311
Info técnica en pág 311



0507

OBLONG

LEATHER / ZAMAK

Designer: Frank Person

Finishes Acabados

Polished chrome + Beige / Brown / Black
Cromo brillo + Beige / Marrón / Negro

Brushed gold + Beige / Brown / Black
Oro cepillado + Beige / Marrón / Negro

Brushed grey + Beige / Brown / Black
Gris cepillado + Beige / Marrón / Negro

Matt white + Beige
Blanco mate + Beige

Matt black + Beige / Brown / Black
Negro mate + Beige / Marrón / Negro

| | |
|--------|--------|
| ←→ | o — o |
| 70 mm | - |
| 197 mm | 160 mm |



⊕
Technical info on page 313
Info técnica en pág 313



0494

LAND

ZAMAK

Designer: Héctor Diego

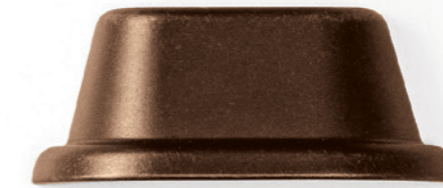

Finishes
Acabados

Brushed gold
Oro cepillado

Pewter
Peltre

Antique brass
Latón antiguo

Matt black
Negro mate

| | |
|-----------|-------|
| ←→ | o — o |
| 40 (Ø) mm | - |
| 98 mm | 64 mm |

⊕
Technical info on page 314
Info técnica en pág 314



0494

LAND

ZAMAK

Designer: Héctor Diego



**Finishes
Acabados**

Brushed gold
Oro cepillado

Pewter
Peltre

Antique brass
Latón antiguo

Matt black
Negro mate



40 (Ø) mm

98 mm

-

64 mm



Technical info on page 314
Info técnica en pág 314



0516

PENDANT

ZAMAK

Designer: Frank Person



Finishes
Acabados

Pewter
Peltre

Antique brass
Latón antiguo

Matt black
Negro mate

| | |
|----------|--------|
| ←→ | o — o |
| 39,3 mm | - |
| 138,4 mm | 128 mm |

⊕
Technical info on page 316
Info técnica en pág 316



0516

PENDANT

ZAMAK

Designer: Frank Person



Finishes
Acabados

Pewter
Peltre

←→
39,3 mm
138,4 mm

o — o
-
128 mm

Antique brass
Latón antiguo

Matt black
Negro mate



Technical info on page 316
Info técnica en pág 316



0486

GRAF BIG

ALUMINIUM

Designer: Viefe Studio

Finishes
Acabados

| | ←→ | o — o 1 | o — o 2 |
|--|-----------|---------|---------|
| Stainless steel look <i>Inox look</i> | (Ø) 38 mm | - | - |
| | (Ø) 50 mm | - | - |
| Brushed brass <i>Latón cepillado</i> | 224 mm | 192 mm | - |
| | 352 mm | 320 mm | - |
| Brushed black <i>Negro cepillado</i> | 1200 mm | 1168 mm | 584 mm |



Technical info on page 317
Info técnica en pág 317



0486

GRAF BIG

ALUMINIUM

Designer: Viefe Studio



Finishes
Acabados

Stainless steel look
Inox look

Brushed brass
Latón cepillado

Brushed black
Negro cepillado



| ↳← | o — o 1 | o — o 2 |
|-----------|---------|---------|
| (Ø) 38 mm | - | - |
| (Ø) 50 mm | - | - |
| 224 mm | 192 mm | - |
| 352 mm | 320 mm | - |
| 1200 mm | 1168 mm | 584 mm |



Technical info on page 317
Info técnica en pág 317

0486

GRAF BIG

ALUMINIUM

Designer: Viefe Studio



Finishes
Acabados

Stainless steel look
Inox look

Brushed brass
Latón cepillado

Brushed black
Negro cepillado

| ←→ | o — o 1 | o — o 2 |
|-----------|---------|---------|
| (Ø) 38 mm | - | - |
| (Ø) 50 mm | - | - |
| 224 mm | 192 mm | - |
| 352 mm | 320 mm | - |
| 1200 mm | 1168 mm | 584 mm |

⊕
Technical info on page 317
Info técnica en pág 317



0430

GRAF MINI

ALUMINIUM

Designer: Viefe Studio

Finishes
Acabados

| | ←→ | ○ — ○ 1 | ○ — ○ 2 |
|--|---------|---------|---------|
| Stainless steel look <i>Inox look</i> | 10 mm | - | - |
| Brushed brass <i>Latón cepillado</i> | 182 mm | 160 mm | - |
| Brushed black <i>Negro cepillado</i> | 278 mm | 256 mm | - |
| | 1200 mm | 1178 mm | 589 mm |

Includes non-twisting tip / Incluye punta anti-giro



⊕
Technical info on page 317
Info técnica en pág 317

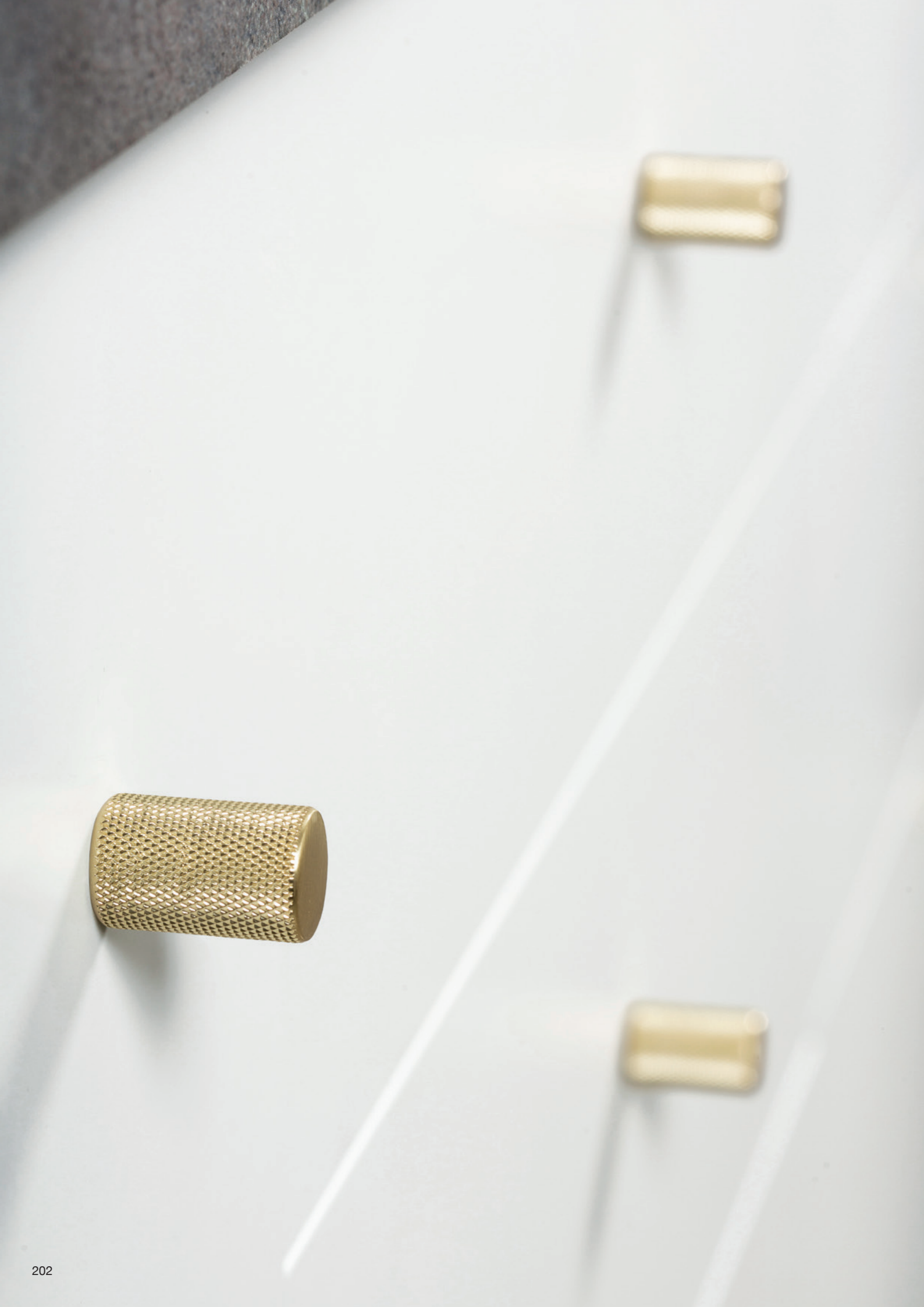

0109

GRAF

ALUMINIUM

Designer: Viefe Studio

Finishes
Acabados

Polished chrome
Cromo brillo

Anodized matt
Anodizado mate

Stainless steel look
Inox look

Brushed brass
Latón cepillado

Matt black
Negro mate



17,5 mm



Technical info on page 318
Info técnica en pág 318



0459

LINES

ZAMAK

Designer: Teruel & Paré

Finishes Acabados

Brushed Níquel
Níquel cepillado

Brushed gold
Oro cepillado

Brushed mole grey
Gris topo cepillado

Matt black
Negro mate

← →

170 mm

330 mm

o — o

160 mm

320 mm



Technical info on page 315
Info técnica en pág 315

0446

ESTE

ZAMAK

Designer: Balutto Associati



Finishes
Acabados

Polished chrome
Cromo brillo

Matt chrome
Cromo mate

Brushed nickel
Niquel cepillado

Brushed copper
Cobre cepillado

Brushed gold
Oro cepillado

Graphite grey
Gris grafito

Matt black
Negro mate

←→ | o — o
172 mm 160 mm

⊕
Technical info on page 314
Info técnica en pág 314



0447

BELLA

ZAMAK

Designer: Balutto Associati

Finishes
Acabados

Brushed copper
Cobre cepillado

Brushed gold
Oro cepillado

Graphite grey
Gris grafito

Matt black
Negro mate

←→ | ○ — ○
176 mm 160 mm

⊕
Technical info on page 318
Info técnica en pág 318





0449

HEXXA

ALUMINIUM + ZAMAK

Designer: Alexis Vivet

Finishes
Acabados

| | | |
|---------------------------------------|-----------|--|
| | ←→ | |
| Matt white <i>Blanco mate</i> | 200 mm | |
| | 350 mm | |
| Matt black <i>Negro mate</i> | 1100 mm | |
| | 3000 mm * | |
| Metallic grey <i>Gris metal</i> | | |
| Metallic brown <i>Marrón metal</i> | | |

* Three metre profiles are delivered according to the units of the original packaging and cannot be sold separately.
Las barras de tres metros se sirven según las cantidades del embalaje original y no se pueden servir por separado.



Technical info on page 319
Info técnica en pág 319

0449

HEXXA

ALUMINIUM + ZAMAK

Designer: Alexis Vivet

Finishes Acabados

Matt white
Blanco mate

Matt black
Negro mate

Metallic grey
Gris metal

Metallic brown
Marrón metal

|←→|

200 mm

350 mm

1100 mm

3000 mm *

* Three metre profiles are delivered according to the units of the original packaging and cannot be sold separately.

Las barras de tres metros se sirven según las cantidades del embalaje original y no se pueden servir por separado.



Technical info on page 319
Info técnica en pág 319





0094

HIDE

ZAMAK

Designer: Viefe Studio



Finishes
Acabados

| | ←→ | o — o |
|---|--------|--------|
| Polished chrome <i>Cromo brillo</i> | 90 mm | 64 mm |
| Brushed nickel <i>Níquel cepillado</i> | 180 mm | 128 mm |
| Brushed gold <i>Oro cepillado</i> | 200 mm | 128 mm |
| Matt white <i>Blanco mate</i> | | |
| Matt black <i>Negro mate</i> | | |
| Chrome look <i>Cromo look</i> | | |

⊕
Technical info on page 316
Info técnica en pág 316



0119

WAVE

ZAMAK

Designer: Viefe Studio



Finishes
Acabados

Polished chrome
Cromo brillo

Brushed nickel
Níquel cepillado

Matt black
Negro mate

←→

45 mm
173 mm

o — o

32 mm
160 mm



Technical info on page 319
Info técnica en pág 319



0105

(combinable with 0094)

NEST

ZAMAK

Designer: Viefte Studio



Finishes
Acabados

Polished chrome
Cromo brillo

Brushed nickel
Níquel cepillado

Polished chrome + White
Cromo brillo + Blanco

Brushed nickel + White
Níquel cepillado + Blanco

Matt black
Negro mate

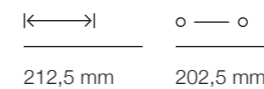

Technical info on page 320
Info técnica en pág 320



0235

CLOS

ZAMAK

Designer: Viefe Studio



Finishes

Acabados

Matt white
Blanco mate

Matt black
Negro mate

Polished chrome
Cromo brillo

Brushed nickel
Níquel cepillado



160 mm



128 mm



Technical info on page 320
Info técnica en pág 320

0366

CUBIC

ZAMAK

Designer: Viefe Studio

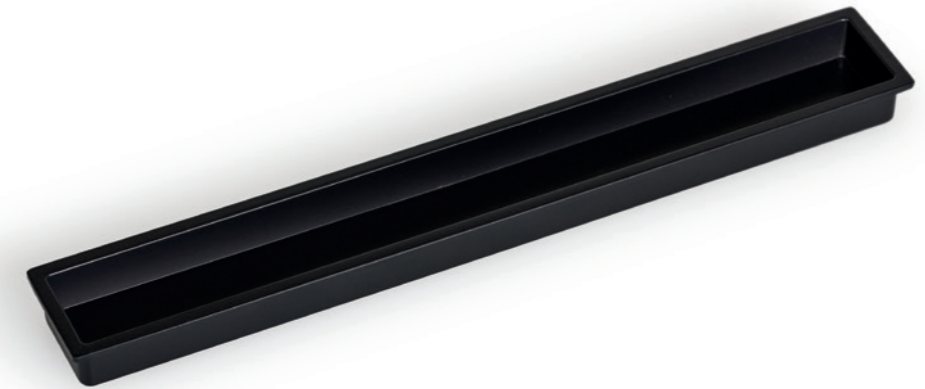

Finishes
Acabados

Matt white
Blanco mate

Matt black
Negro mate

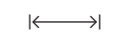

160 mm



Technical info on page 320
Info técnica en pág 320

0073

TAP

ZAMAK

Designer: Viefe Studio



Finishes
Acabados

Chrome look
Cromo look

Matt black
Negro mate

∅ 1

35,5 mm

55,3 mm

∅ 2

40 mm

60 mm



Technical info on page 321
Info técnica en pág 321



0301

SENSE MINI

ALUMINIUM

Designer: Viefte Studio



Finishes
Acabados

Polished chrome
Cromo brillo

Matt black
Negro mate

Stainless steel look
Inox look

Brushed dark brass
Latón oscuro cepillado

| ←→ | o — o |
|--------|--------|
| 103 mm | 96 mm |
| 167 mm | 160 mm |
| 263 mm | 256 mm |

⊕
Technical info on page 321
Info técnica en pág 321



0195

SENSE

ALUMINIUM

Designer: Viefe Studio



Finishes
Acabados

Polished chrome
Cromo brillo

Stainless steel look
Inox look

Brushed black
Negro cepillado

| | |
|--------|--------|
| ←→ | ○ — ○ |
| 135 mm | 128 mm |
| 199 mm | 192 mm |
| 327 mm | 320 mm |
| 487 mm | 480 mm |

⊕
Technical info on page 321
Info técnica en pág 321



0451

FELTRE

ZAMAK

Designer: Balutto Associati

Finishes
Acabados

Brushed nickel
Níquel cepillado

Graphite grey
Gris grafito

Matt black
Negro mate

←→ | o — o
218 mm 192 mm



Technical info on page 318
Info técnica en pág 318



0452

BRAVE

ALUMINIUM

Designer: Viefe Studio



Finishes
Acabados

Matt white
Blanco mate

Matt black
Negro mate

Metallic grey
Gris metal

Metallic brown
Marrón metal

| ↳—→ | ○ — ○ 1 | ○ — ○ 2 |
|---------|---------|---------|
| 160 mm | 128 mm | - |
| 240 mm | 192 mm | - |
| 400 mm | 320 mm | - |
| 600 mm | 192 mm | 480 mm |
| 1040 mm | 192 mm | 992 mm |
| 1150 mm | 192 mm | 1120 mm |



Technical info on page 324
Info técnica en pág 324

0444

PEAK

ALUMINIUM

Designer: Viefe Studio



Finishes
Acabados

Stainless steel look
Inox look

Brushed black
Negro cepillado

Matt white
Blanco mate

Metallic grey
Gris metal

Metallic brown
Marrón metal

| ←→ | o — o 1 | o — o 2 |
|---------|---------|---------|
| 120 mm | 64 mm | - |
| 250 mm | 192 mm | 160 mm |
| 500 mm | 448 mm | 160 mm |
| 800 mm | 768 mm | 160 mm |
| 1150 mm | 1120 mm | 160 mm |
| 1800 mm | 1760 mm | 160 mm |

⊕
Technical info on page 325
info técnica en pág 325



0375

VANN

ALUMINIUM

Designer: Alexis Vivet



Finishes
Acabados

Anodized bright
Anodizado brillo

Anodized matt
Anodizado mate

Matt black
Negro mate

Stainless steel look
Inox look

Brushed dark brass
Latón oscuro cepillado

| | ◀—▶ | ○ — ○ 1 | ○ — ○ 2 |
|----------------------|---------|---------|---------|
| Anodized bright | 100 mm | 64 mm | - |
| Anodized matt | 200 mm | 128 mm | - |
| Matt black | 350 mm | 256 mm | - |
| Stainless steel look | 1200 mm | 1120 mm | 384mm |

⊕
Technical info on page 325
Info técnica en pág 325



Finishes

Acabados

Anodized bright
Anodizado brillo

Anodized matt
Anodizado mate

Matt black
Negro mate

Stainless steel look
Inox look

Brushed dark brass
Latón oscuro cepillado

| ←→ | ○ — ○ 1 | ○ — ○ 2 |
|---------|---------|---------|
| 100 mm | 64 mm | - |
| 200 mm | 128 mm | - |
| 350 mm | 256 mm | - |
| 1200 mm | 1120 mm | 384mm |



Technical info on page 325
Info técnica en pág 325

0117

CURVE

ALUMINIUM

Designer: Viefe Studio

Finishes

Acabados

Anodized matt
Anodizado mate

Stainless steel look
Inox look

Brushed grey
Gris cepillado

Matt white
Blanco mate

Matt black
Negro mate

←→

o — o

45 mm

32 mm

100 mm

64 mm

200 mm

128 mm

300 mm

192 mm

400 mm

320 mm

500 mm

416 mm



Technical info on page 327
Info técnica en pág. 327

0139 / 0140

LINEAR

ALUMINIUM

Designer: Viefe Studio



Finishes
Acabados

Stainless steel look
Inox look

Brushed black
Negro cepillado

←→

147 mm

197 mm

247 mm

297 mm

347 mm

397 mm

447 mm

497 mm

597 mm

697 mm

797 mm

897 mm

997 mm

1197 mm



Technical info on page 327
Info técnica en pág 327

0434

VECTOR

ALUMINIUM

Designer: Viefe Studio



Finishes Acabados

Stainless steel look
Inox look

Brushed black
Negro cepillado

Brushed grey
Gris cepillado

←→

147 mm

197 mm

247 mm

297 mm

347 mm

397 mm

447 mm

497 mm

597 mm

697 mm

797 mm

897 mm

997 mm

1197 mm



Technical info on page 328
Info técnica en pág 328



0343

GRADA

ALUMINIUM

Designer: Viefe Studio

Finishes Acabados

|←→|

| | |
|--|-----------|
| Anodized matt <i>Anodizado mate</i> | 147 mm |
| | 197 mm |
| Stainless steel look <i>Inox look</i> | 247 mm |
| | 297 mm |
| Matt white <i>Blanco mate</i> | 347 mm |
| | 397 mm |
| Matt black <i>Negro mate</i> | 447 mm |
| | 497 mm |
| Anodized bright <i>Anodizado brillo</i> | 597 mm |
| | 697 mm |
| | 797 mm |
| | 897 mm |
| | 997 mm |
| | 1197 mm |
| | 3000 mm * |

*
Three metre profiles are delivered according to the units of the original packaging and cannot be sold separately.

Las barras de tres metros se sirven según las cantidades del embalaje original y no se pueden servir por separado.



Technical info on page 330
Info técnica en pág 330

0380

STEEP

ALUMINIUM

Designer: Viefe Studio

Finishes
Acabados

Anodized bright
Anodizado brillo

Stainless steel look
Inox look

Matt black
Negro mate



3000 mm

Three metre profiles are delivered according to the units of the original packaging and cannot be sold separately.

Las barras de tres metros se sirven según las cantidades del embalaje original y no se pueden servir por separado.



Technical info on page 330
Info técnica en pág 330

0250 / 0251

FORMA

ALUMINIUM

Designer: 2J Design



147 mm

197 mm

247 mm

297 mm

347 mm

397 mm

Finishes
Acabados

Stainless steel look
Inox look

447 mm

497 mm

597 mm

697 mm

797 mm

897 mm

997 mm

1197 mm



Technical info on page 329
Info técnica en pág 329

0334

BRIKK

ALUMINIUM

Designer: Alexis Vivet

Finishes Acabados

| | ←→ | ○ — ○ 1 | ○ — ○ 2 | ○ — ○ 3 |
|---------|--------|---------|---------|---------|
| 140 mm | 32 mm | - | - | - |
| 190 mm | 64 mm | - | - | - |
| 240 mm | 96 mm | - | - | - |
| 290 mm | 160 mm | - | - | - |
| 340 mm | 192 mm | - | - | - |
| 390 mm | 128 mm | 260 mm | - | - |
| 440 mm | 160 mm | 310 mm | - | - |
| 490 mm | 192 mm | 360 mm | - | - |
| 590 mm | 224 mm | 460 mm | - | - |
| 690 mm | 256 mm | 560 mm | - | - |
| 790 mm | 320 mm | 660 mm | - | - |
| 890 mm | 384 mm | 760 mm | - | - |
| 990 mm | 320 mm | 640 mm | 860 mm | - |
| 1190 mm | 320 mm | 832 mm | 1060 mm | - |



⊕
 Technical info on page 329
 Info técnica en pág 329



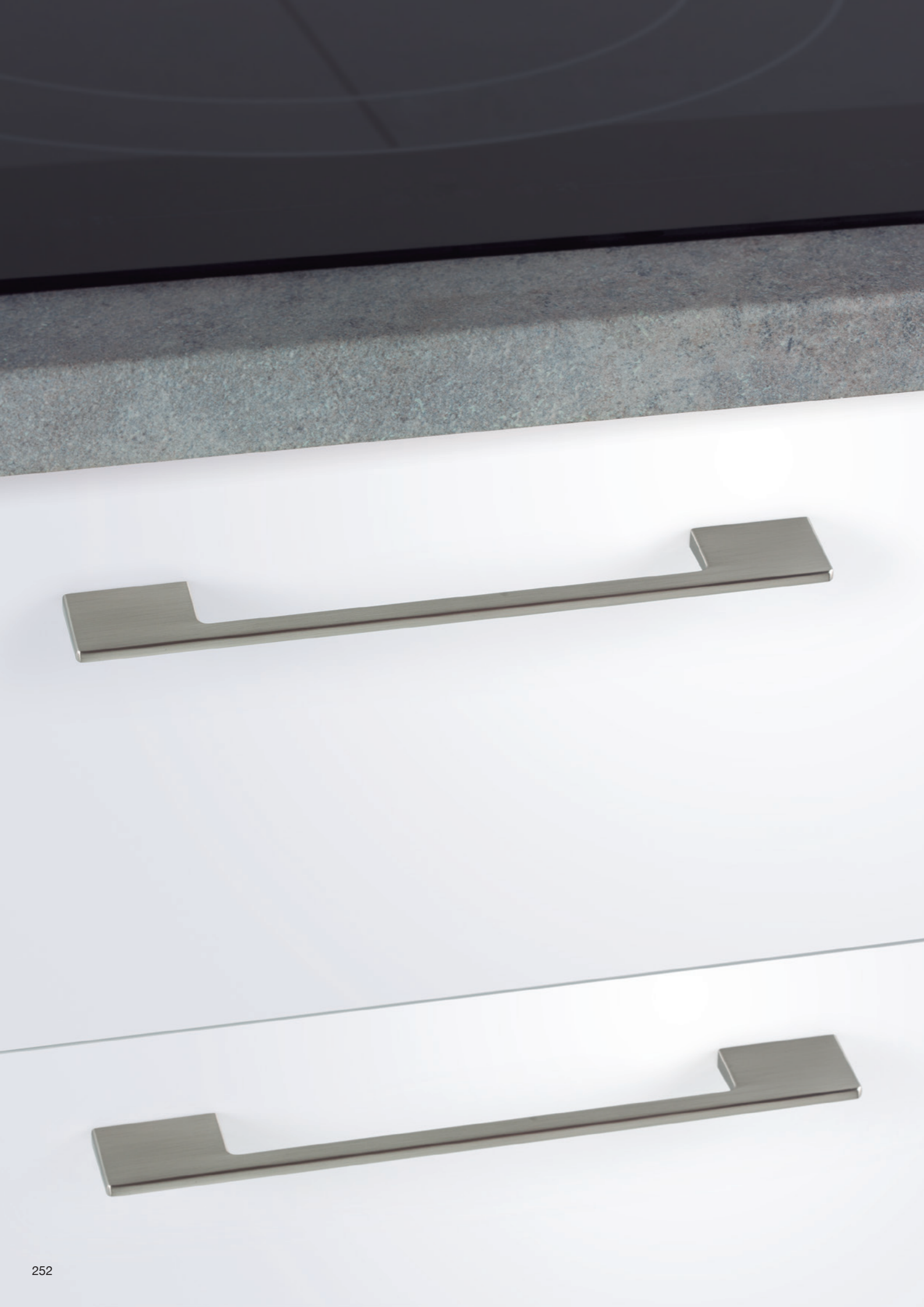

0053

DINO

ZAMAK

Designer: Viefe Studio



Finishes
Acabados

Polished chrome
Cromo brillo

Brushed nickel
Niquel cepillado

Matt white
Blanco mate

Matt black
Negro mate

Aluminium look
Aluminio look

| ←→ | o — o 1 | o — o 2 |
|--------|---------|---------|
| 156 mm | 96 mm | 128 mm |
| 221 mm | 160 mm | 192 mm |
| 349 mm | 288 mm | 320 mm |

⊕
Technical info on page 326
Info técnica en pág 326



0373

NICK

ZAMAK

Designer: Alexis Vivet



Finishes
Acabados

Polished chrome
Cromo brillo

Brushed nickel
Níquel cepillado

Brushed copper
Cobre cepillado

Brushed brass
Latón cepillado

| | |
|--------|--------|
| ←→ | o — o |
| 50 mm | 32 mm |
| 178 mm | 160 mm |

⊕
Technical info on page 322
Info técnica en pág 322

0322

CUTT

ALUMINIUM

Designer: Alexis Vivet

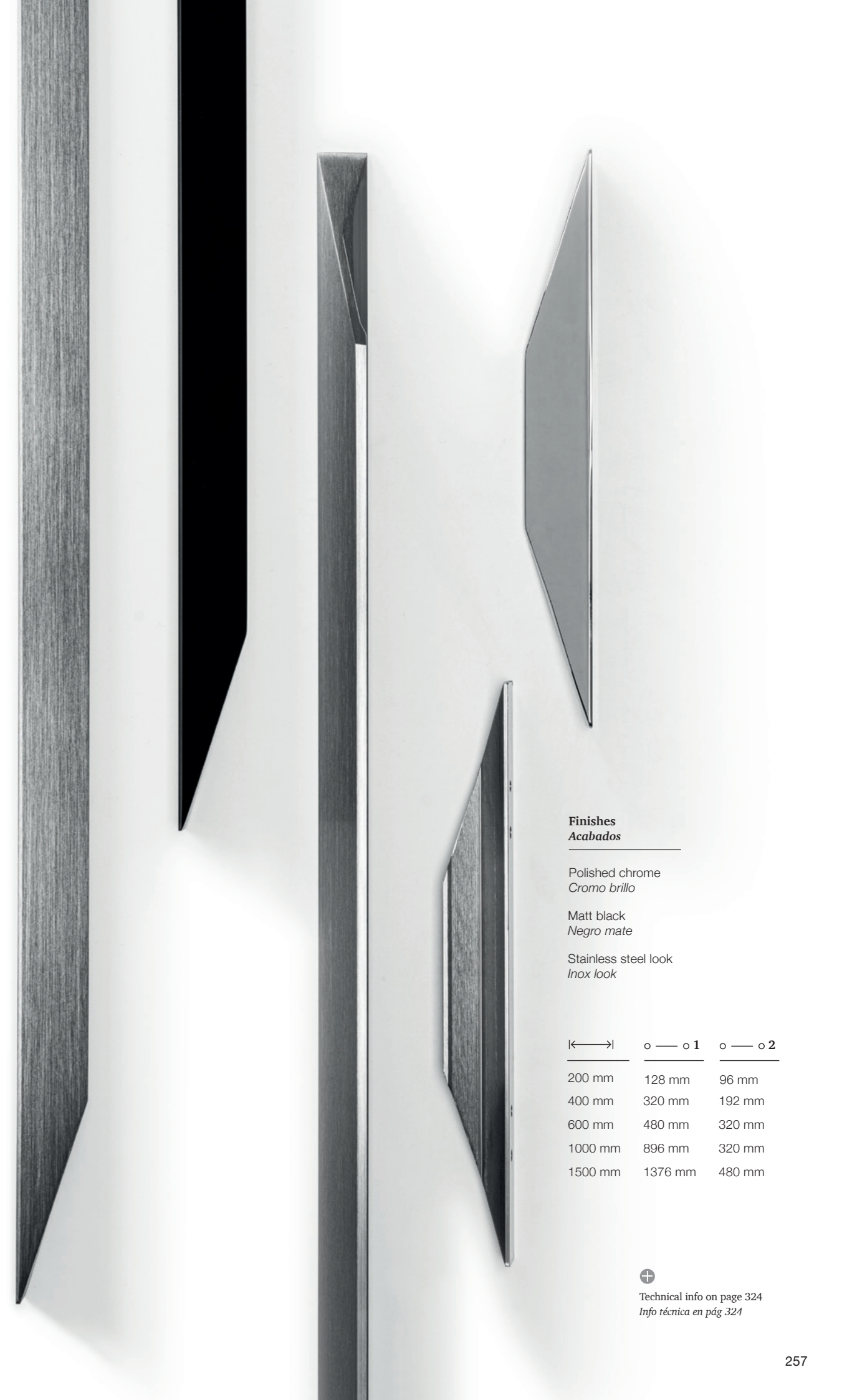

Finishes
Acabados

Polished chrome
Cromo brillo

Matt black
Negro mate

Stainless steel look
Inox look

| $\leftarrow \rightarrow$ | $\circ \text{---} \circ 1$ | $\circ \text{---} \circ 2$ |
|--------------------------|----------------------------|----------------------------|
| 200 mm | 128 mm | 96 mm |
| 400 mm | 320 mm | 192 mm |
| 600 mm | 480 mm | 320 mm |
| 1000 mm | 896 mm | 320 mm |
| 1500 mm | 1376 mm | 480 mm |



Technical info on page 324
Info técnica en pág 324



0410

BUTTON

ZAMAK

Designer: Alexis Vivet

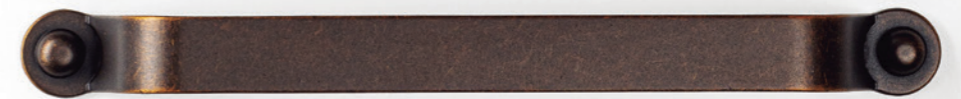

Finishes
Acabados

Pewter
Peltre

Antique Brass
Latón antiguo

Matt black
Negro mate

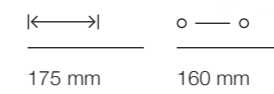

⊕
Technical info on page 331
Info técnica en pág 331



0393

DUKE

ZAMAK

Designer: Viefte Studio



Finishes
Acabados

Antique copper
Cobre antiguo

Antique silver
Plata antigua

Matt black
Negro mate

Matt white
Blanco mate

Pewter
Peltre

Antique Brass
Latón antiguo

Polished chrome
Cromo brillo

Brushed nickel
Níquel cepillado

Brushed brass
Latón cepillado

Brushed copper
Cobre cepillado



31,4 mm



Technical info on page 331
Info técnica en pág 331

0226

REDO

ZAMAK

Designer: 2J Design



Finishes
Acabados

Antique Brass
Latón antiguo

Brushed nickel
Níquel cepillado

Brushed copper
Cobre cepillado

Pewter
Peltre

←→

o — o

137 mm

128 mm

201 mm

192 mm



Technical info on page 332
Info técnica en pag 332



0405

RAVIOLO

ZAMAK

Designer: Balutto Associati



Finishes
Acabados

Pewter
Peltre

Antique Brass
Latón antiguo

← →

Ø 29 mm

172 mm

○ — ○

-

96 mm



Technical info on page 332
Info técnica en pág 332

0394

AVA

ZAMAK



Designer: Viefe Studio



Finishes
Acabados

Pewter
Peltre

Antique Brass
Latón antiguo



 128,5 mm 96 mm

 Technical info on page 332
Info técnica en pág 332

0390

PETRA

ZAMAK

Designer: Viefe Studio





Finishes
Acabados

Antique copper
Cobre antiguo

Antique silver
Plata antigua

Matt black
Negro mate



 97 mm 64 mm

 Technical info on page 333
Info técnica en pág 333

0392

ORION

ZAMAK

Designer: Viefe Studio



Finishes
Acabados

Antique copper
Cobre antiguo

Antique silver
Plata antigua



136 mm



128 mm



Technical info on page 333
Info técnica en pág 333



0391

AURA

ZAMAK

Designer: Viefe Studio



Finishes
Acabados

Antique copper
Cobre antiguo

Antique silver
Plata antigua



87 mm



64 mm



Technical info on page 333
Info técnica en pág 333





Finishes
Acabados

Polished chrome + Beige / Brown / Black
Cromo brillo + Beige / Marrón / Negro

Pewter + Beige / Brown / Black
Peltre + Beige / Marrón / Negro

Matt black + Beige / Brown / Black
Negro mate + Beige / Marrón / Negro

Brushed brass + Beige / Brown / Black
Latón cepillado + Beige / Marrón / Negro

| | |
|--------|--------|
| ←→ | ○ — ○ |
| 70 mm | - |
| 150 mm | 128 mm |
| 182 mm | 160 mm |

⊕
Technical info on page 334
Info técnica en pág 334

0239

ARA W

ALUMINIUM + WOOD

Designer: 2J Design



Finishes
Acabados

Stainless steel look + Oak
Inox look + Roble

Stainless steel look + Walnut
Inox look + Nogal

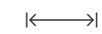

220 mm
284 mm



160 mm
224 mm



Technical info on page 334
Info técnica en pág 334



0340

BARCCO

WOOD

Designer: Alexis Vivet



Finishes
Acabados

Ash
Fresno

Walnut
Nogal

Beech raw
Haya crudo

| K → | o — o 1 | o — o 2 |
|--------|---------|---------|
| 200 mm | 160 mm | - |
| 400 mm | 320 mm | - |
| 600 mm | 320 mm | 480 mm |

⊕
Technical info on page 335
Info técnica en pág 335

0165

CALIN

WOOD

Designer: Viefe Studio



Finishes Acabados

Raw brushed
Crudo cepillado

White brushed
Blanco cepillado

Brown brushed
Marrón cepillado

Black brushed
Negro cepillado

←→ | o — o
240 mm 160 mm

⊕
Technical info on page 335
Info técnica en pág. 335



0166

ECHO

WOOD

Designer: Viefe Studio



Finishes Acabados

Raw brushed
Crudo cepillado

White brushed
Blanco cepillado

Brown brushed
Marrón cepillado

Black brushed
Negro cepillado



60 mm



Technical info on page 335
Info técnica en pág. 335

0374

BALL

ZAMAK

Designer: Alexis Vivet



Finishes Acabados

Polished chrome
Cobre brillo

Brushed nickel
Níquel cepillado

Brushed brass
Latón cepillado



23,3 mm

29,5 mm

⊕
Technical info on page 336
Info técnica en pág. 336

0243 ST

LOW ST

ZAMAK

Designer: Viefe Studio

Finishes Acabados

Brushed nickel
Níquel cepillado

| | |
|--------|--------|
| ←→ | ○ — ○ |
| 78 mm | 64 mm |
| 206 mm | 192 mm |

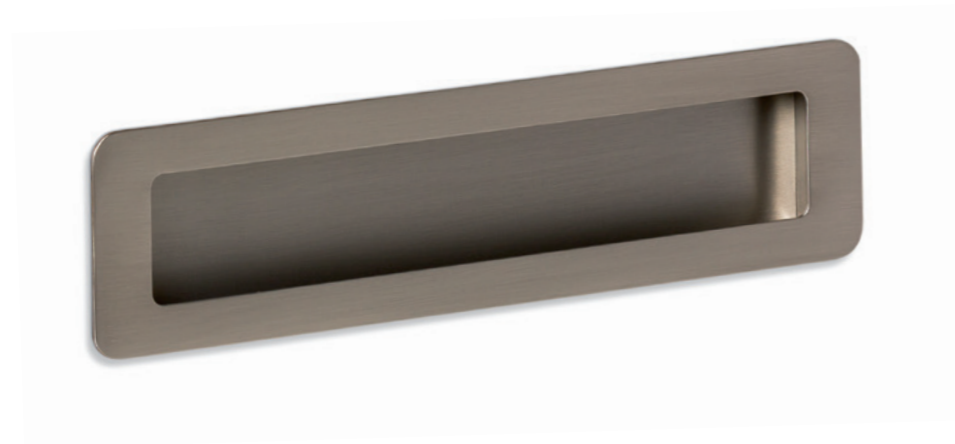

⊕
Technical info on page 336
Info técnica en pág 336

0281

FLAT

ZAMAK

Designer: Oriol Barri

Finishes Acabados

Brushed nickel
Níquel cepillado

| | |
|----------|--------|
| ←→ | ○ — ○ |
| 174,8 mm | 160 mm |

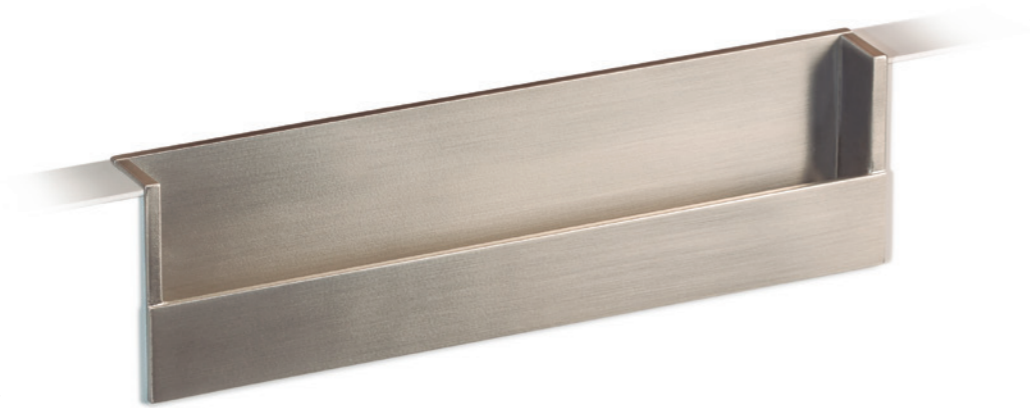

⊕
Technical info on page 336
Info técnica en pág 336

0369

RITTA

ALUMINIUM

Designer: Teruel & Paré

Finishes Acabados

Polished chrome
Cromo brillo

Matt black
Negro mate

Stainless steel look
Inox look



| | |
|--------|--------|
| ←→ | ○ — ○ |
| 130 mm | 64 mm |
| 260 mm | 128 mm |

⊕
Technical info on page 337
Info técnica en pág 337

0219

ARROW

ZAMAK

Designer: 2J Design

Finishes Acabados

Brushed nickel
Níquel cepillado



| | |
|--------|--------|
| ←→ | ○ — ○ |
| 223 mm | |
| | 192 mm |

⊕
Technical info on page 331
Info técnica en pág 331

0376

BOXX

ZAMAK

Designer: Alexis Vivet



0091

RASO

ZAMAK

Designer: Viefte Studio



Finishes
Acabados

| | ←→ | o — o |
|---|----------|--------|
| Brushed nickel <i>Níquel cepillado</i> | 70 mm | 32 mm |
| | 152,5 mm | 108 mm |



Technical info on page 337
Info técnica en pág 337



Finishes
Acabados

| | ←→ |
|---|-------|
| Polished chrome <i>Cromo brillo</i> | 15 mm |
| Matt chrome <i>Cromo mate</i> | |
| Brushed nickel <i>Níquel cepillado</i> | |
| Matt black <i>Negro mate</i> | |



Technical info on page 337
Info técnica en pág 337

0312

ARKO

ALUMINIUM

Designer: Viefte Studio



Finishes
Acabados

Stainless steel look
Inox look

| | ←→ | o — o |
|--|--------|--------|
| | 186 mm | 160 mm |
| | 218 mm | 192 mm |
| | 292 mm | 256 mm |



Technical info on page 338
Info técnica en pág 338

0206

ARCH

ZAMAK

Designer: 2J Design

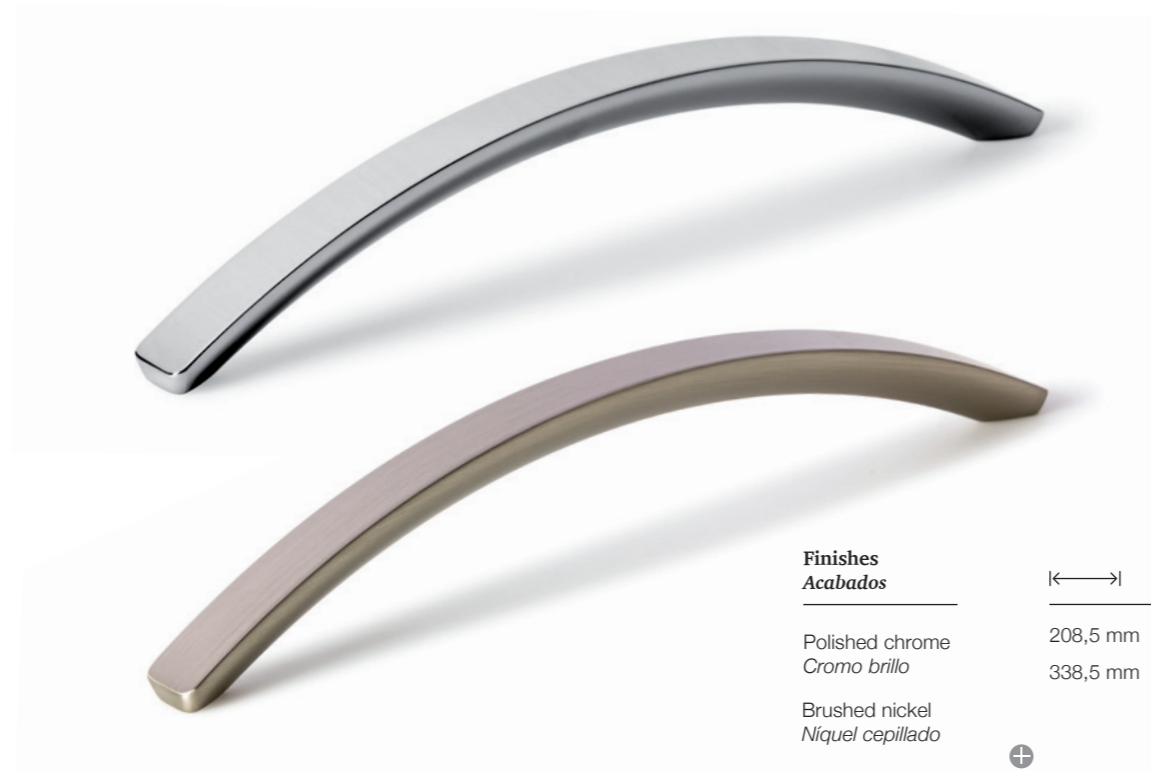

**Finishes
Acabados**

Polished chrome
Cromo brillo

Brushed nickel
Níquel cepillado

| | ←→ | o — o |
|---|----------|--------|
| Polished chrome <i>Cromo brillo</i> | 208,5 mm | 192 mm |
| Brushed nickel <i>Níquel cepillado</i> | 338,5 mm | 320 mm |

⊕
Technical info on page 323
Info técnica en pág 323

0064

KOMBI

STAINLESS STEEL

Designer: Viefé Studio



**Finishes
Acabados**

Brushed stainless steel
Inox cepillado

| | ←→ | o — o |
|--|---------|---------|
| Brushed stainless steel <i>Inox cepillado</i> | 182 mm | 160 mm |
| | 214 mm | 192 mm |
| | 314 mm | 292 mm |
| | 364 mm | 342 mm |
| | 414 mm | 392 mm |
| | 514 mm | 492 mm |
| | 814 mm | 792 mm |
| | 1114 mm | 1092 mm |

⊕
Technical info on page 338
Info técnica en pág 338

0162

KADO

ZAMAK

Designer: Viefé Studio

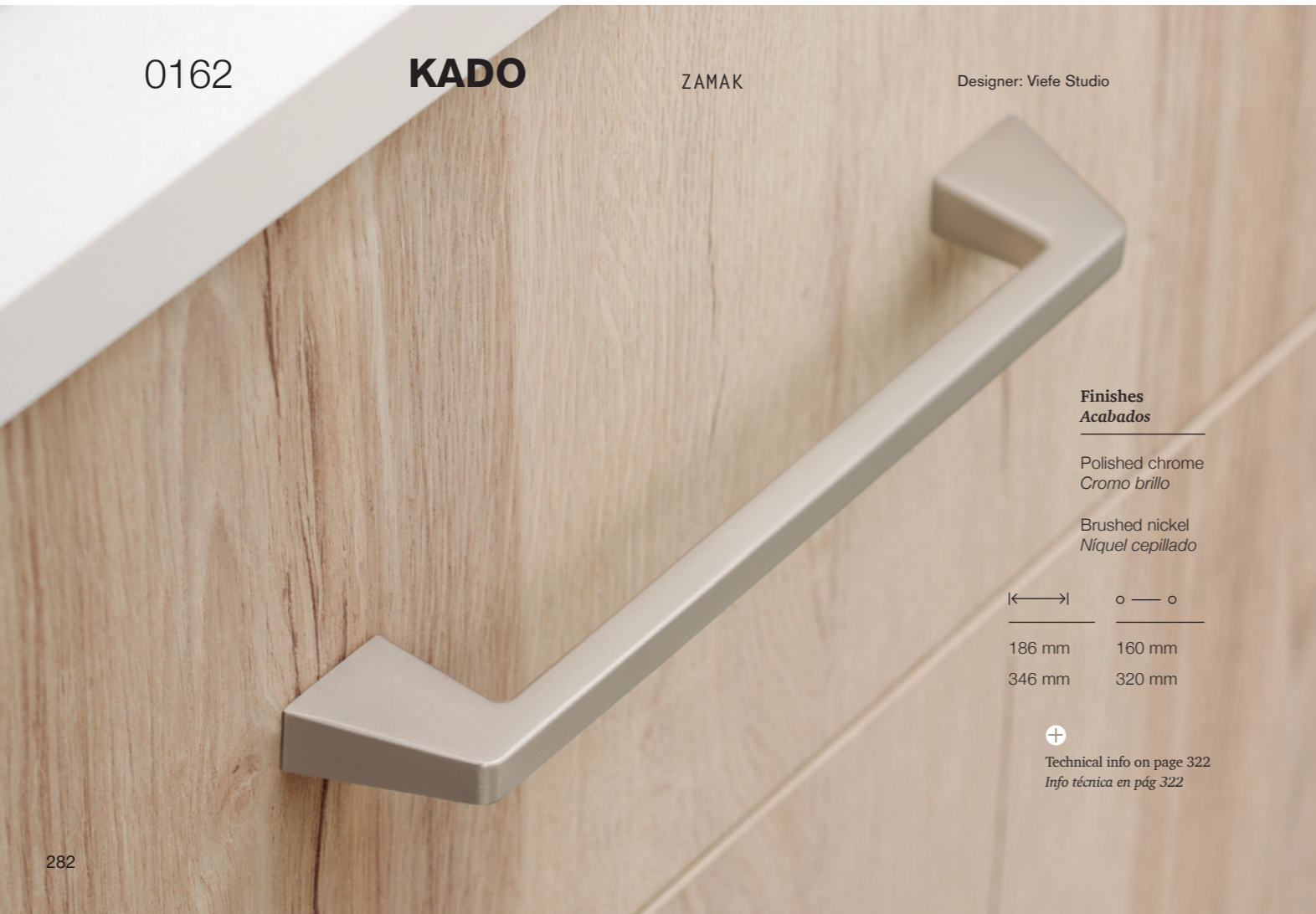

**Finishes
Acabados**

Polished chrome
Cromo brillo

Brushed nickel
Níquel cepillado

| | ←→ | o — o |
|---|--------|--------|
| Polished chrome <i>Cromo brillo</i> | 186 mm | 160 mm |
| Brushed nickel <i>Níquel cepillado</i> | 346 mm | 320 mm |

⊕
Technical info on page 322
Info técnica en pág 322

0035

ACER

STAINLESS STEEL

Designer: 2J Design

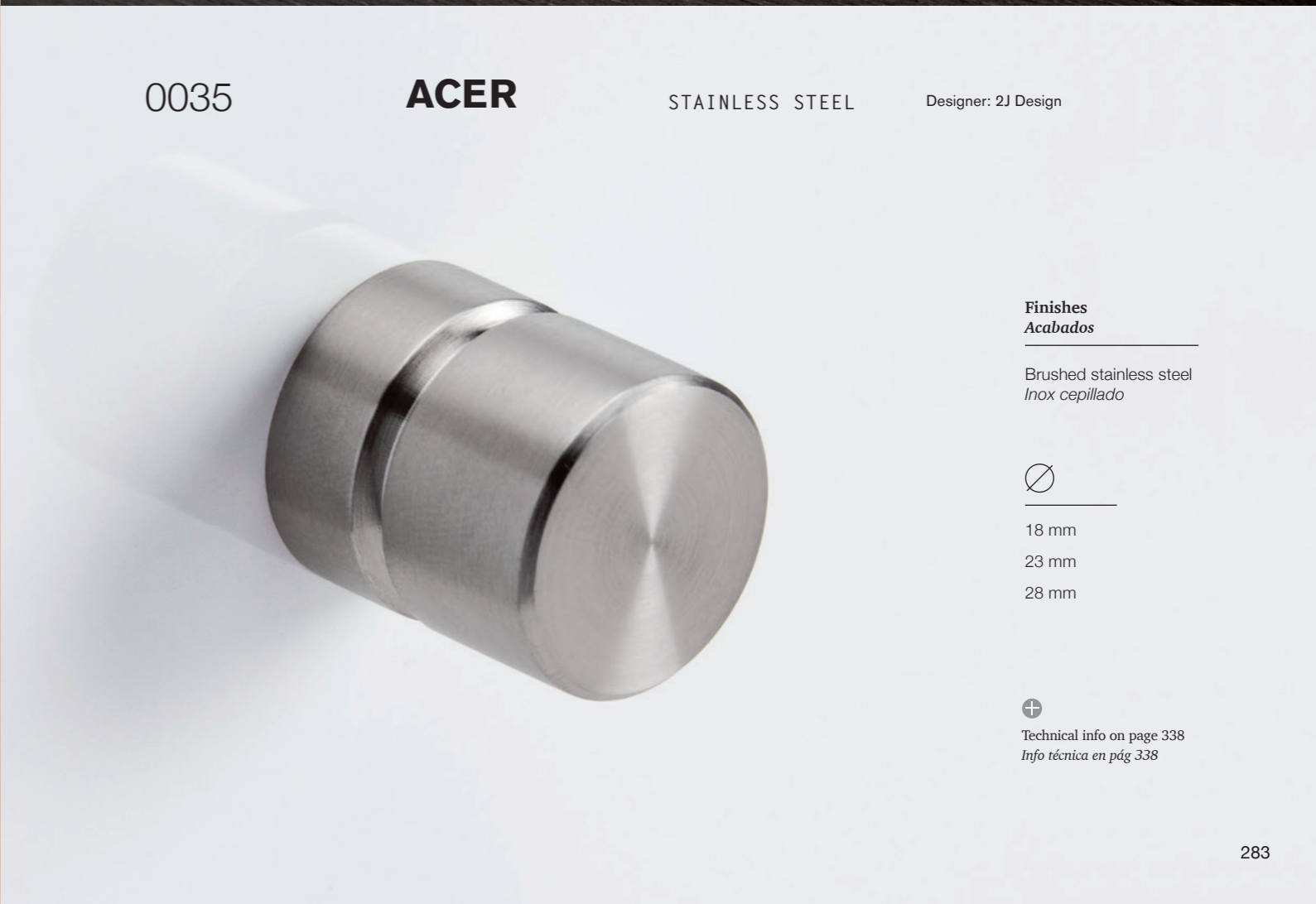

**Finishes
Acabados**

Brushed stainless steel
Inox cepillado

| ∅ |
|-------|
| 18 mm |
| 23 mm |
| 28 mm |

⊕
Technical info on page 338
Info técnica en pág 338

6005

FONDA

ALUMINIUM

Designer: Viefte Studio



Finishes
Acabados

| | ↕ |
|---|--------|
| Polished chrome <i>Cromo brillo</i> | 100 mm |
| Stainless steel look <i>Inox look</i> | 150 mm |
| Brushed dark brass <i>Latón oscuro cepillado</i> | 200 mm |
| Brushed black <i>Negro cepillado</i> | |



Technical info on page 339
Info técnica en pág 339

Viefe[®]

TECH- NICAL *Info*

—
**Información
técnica**

—
**Informació
tècnica**

0636 **POINT** ALUMINIUM Designer: Patricia Roig

NEW!



0636 - 960

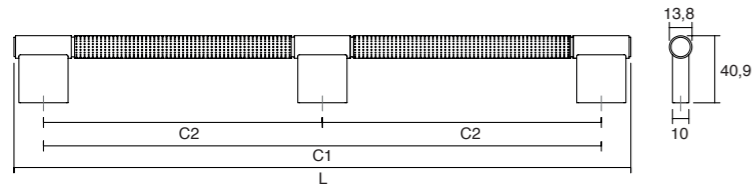

0636 - 192/320

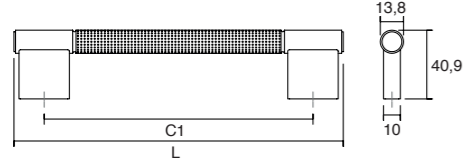

0636 - 110

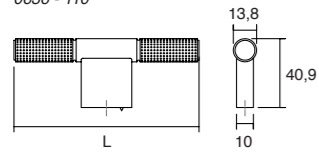

0636 - 040

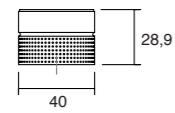

Includes non-twisting tip
Incluye punta anti-giro

| L30 | L33 | L618 | C1 | C2 | L | ↓ | 📦 |
|----------------------------------|---------------------------------|--|-----|-----|-----|---|----|
| Brushed black Negro cepillado | Titanium black Negro titanio | Brushed brass cava Latón cava cepillado | | | | | |
| 0636040L30 | 0636040L33 | 0636040L618 | - | - | Ø40 | 1 | 25 |
| 0636110L30 | 0636110L33 | 0636110L618 | - | - | 110 | 1 | 25 |
| 0636192L30 | 0636192L33 | 0636192L618 | 192 | - | 228 | 2 | 25 |
| 0636320L30 | 0636320L33 | 0636320L618 | 320 | - | 356 | 2 | 25 |
| 0636960L30 | 0636960L33 | 0636960L618 | 960 | 480 | 996 | 3 | 10 |

0635 **LIDD** ZAMAK Designer: Ilja Huber

NEW!

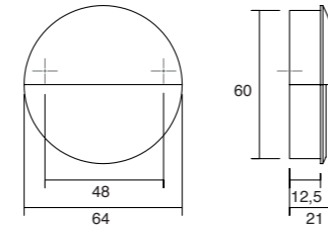
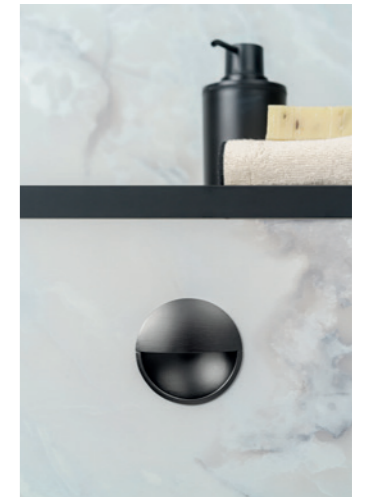

| Z23 | Z33 | Z618 | ZM1 | ZM2 | ↓ | 📦 |
|------------------------------------|---------------------------------|--|---------------------------|--------------------------|---|----|
| Brushed nickel Níquel cepillado | Titanium black Negro titanio | Brushed brass cava Latón cava cepillado | Matt white Blanco mate | Matt black Negro mate | | |
| 0635048Z23 | 0635048Z33 | 0635048Z618 | 0635048ZM1 | 0635048ZM2 | 2 | 25 |

0627 **FUSION** ZAMAK Designer: Ilja Huber

NEW!



0627 - 160/320

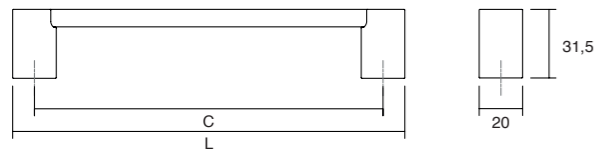

0627 - 058

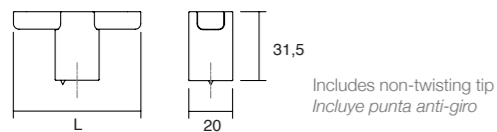

Includes non-twisting tip
Incluye punta anti-giro

| Z33 | Z618 | ZM2 | Z03 | Z05 | Z07 | C | L | ↓ | 📦 |
|---------------------------------|--|--------------------------|---|----------------------------------|--------------------------------|-----|-----|---|----|
| Titanium black Negro titanio | Brushed brass cava Latón cava cepillado | Matt black Negro mate | Polished titanium black Titanio negro brillo | Polished nickel Níquel brillo | Polished brass Latón brillo | | | | |
| 0627058Z33 | 0627058Z618 | 0627058ZM2 | 0627058Z03 | 0627058Z05 | 0627058Z07 | - | 58 | 1 | 25 |
| 0627160Z33 | 0627160Z618 | 0627160ZM2 | 0627160Z03 | 0627160Z05 | 0627160Z07 | 160 | 180 | 2 | 25 |
| 0627320Z33 | 0627320Z618 | 0627320ZM2 | 0627320Z03 | 0627320Z05 | 0627320Z07 | 320 | 340 | 2 | 25 |

0638 **PRISM** ZAMAK Designer: Patricia Roig

NEW!

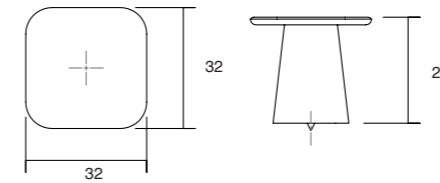
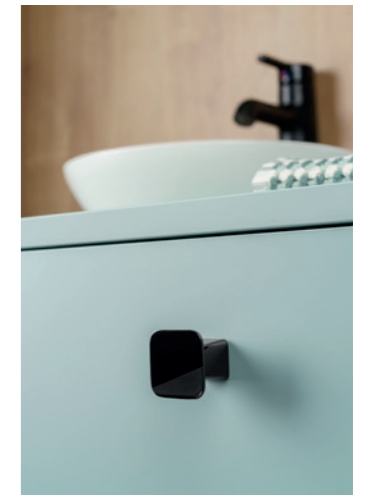

Includes non-twisting tip
Incluye punta anti-giro

| Z33 | Z618 | ZM1 | ZM2 | Z03 | Z05 | Z07 | ↓ | 📦 |
|---------------------------------|--|---------------------------|--------------------------|---|----------------------------------|--------------------------------|---|----|
| Titanium black Negro titanio | Brushed brass cava Latón cava cepillado | Matt white Blanco mate | Matt black Negro mate | Polished titanium black Titanio negro brillo | Polished nickel Níquel brillo | Polished brass Latón brillo | | |
| 0638032Z33 | 0638032Z618 | 0638032ZM1 | 0638032ZM2 | 0638032Z03 | 0638032Z05 | 0638032Z07 | 1 | 25 |

0643 **LINKK** ALUMINIUM Designer: Alexis Vivet

NEW!

0643 - 160/320

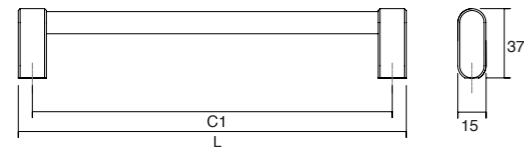

0643 - 1056

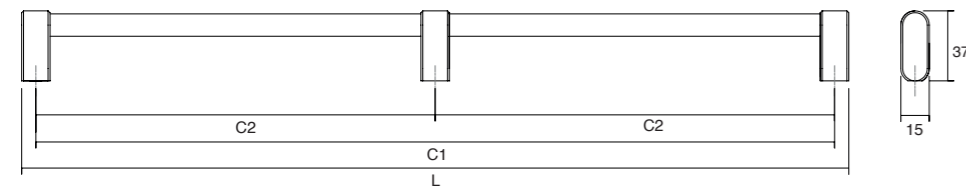

| L24 | L291 | L30 | C1 | C2 | L | ↓ | ☐ |
|--|---|---|------|-----|------|---|----|
| Stainless steel look <i>Inox look</i> | Brushed brass <i>Latón cepillado</i> | Brushed black <i>Negro cepillado</i> | | | | | |
| 0643160L24 | 0643160L291 | 0643160L30 | 160 | - | 175 | 2 | 25 |
| 0643320L24 | 0643320L291 | 0643320L30 | 320 | - | 335 | 2 | 25 |
| 06431056L24 | 06431056L291 | 06431056L30 | 1056 | 528 | 1071 | 3 | 10 |



0650 **MOULE** ZAMAK Designer: Kaschkasch

NEW!

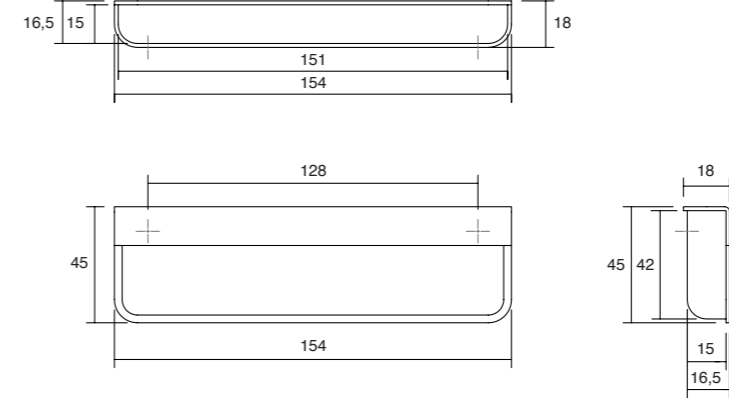

| Z33 | Z618 | ZM1 | ZM2 | ↓ | ☐ |
|--|---|----------------------------------|---------------------------------|---|----|
| Titanium black <i>Negro titanio</i> | Brushed brass cava <i>Latón cava cepillado</i> | Matt white <i>Blanco mate</i> | Matt black <i>Negro mate</i> | | |
| 0650128Z33 | 0650128Z618 | 0650128ZM1 | 0650128ZM2 | 2 | 25 |



0648 **OMEGA** ZAMAK Designer: Kaschkasch

NEW!

0648 - 160

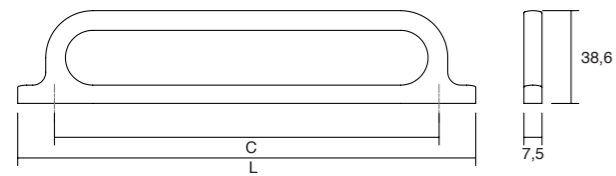

0648 - 32

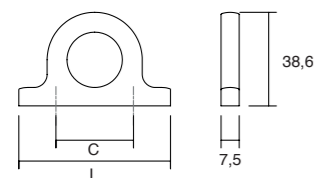

| Z618 | Z623 | ZM2 | C | L | ↓ | ☐ |
|---|--------------------------------------|---------------------------------|-----|-------|---|----|
| Brushed brass cava <i>Latón cava cepillado</i> | Rustic brass <i>Latón rústico</i> | Matt black <i>Negro mate</i> | | | | |
| 0648032Z618 | 0648032Z623 | 0648032ZM2 | 32 | 62,5 | 2 | 25 |
| 0648160Z618 | 0648160Z623 | 0648160ZM2 | 160 | 190,5 | 2 | 25 |



0603 **LIPP** ZAMAK Designer: Alexis Vivet

NEW!

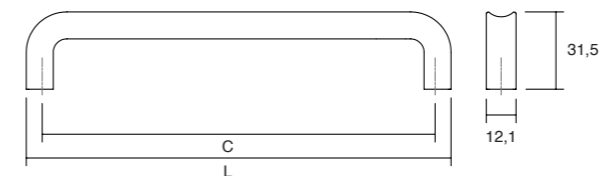

| Z618 | ZM2 | C | L | ↓ | ☐ |
|---|---------------------------------|-----|-----|---|----|
| Brushed brass cava <i>Latón cava cepillado</i> | Matt black <i>Negro mate</i> | | | | |
| 0603192Z618 | 0603192ZM2 | 192 | 205 | 2 | 25 |
| 0603320Z618 | 0603320ZM2 | 320 | 333 | 2 | 25 |

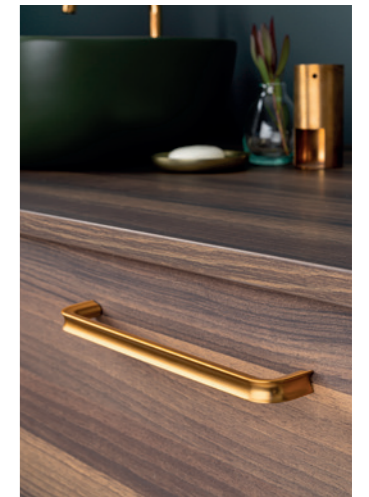

0645 **RISS mini** ALUMINIUM Designer: Kaschkasch **NEW!**

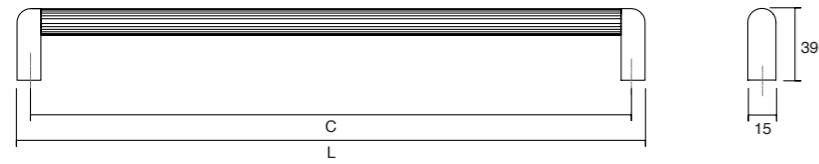

| LM1 | LM2 | LM25 | LM31 | LM43 | LM72 | LM82 | C | L | ↓ | ☐ |
|----------------------------------|---------------------------------|--------------------------------|-------------------------------------|------------------------------------|--------------------------------------|---------------------------------------|-----|-----|---|----|
| Matt white <i>Blanco mate</i> | Matt black <i>Negro mate</i> | Moss grey <i>Gris musgo</i> | Forest green <i>Verde forest</i> | Mocca brown <i>Marrón mocca</i> | Volcano red <i>Rojo volcanico</i> | Midnight blue <i>Azul midnight</i> | | | | |
| 0645192LM1 | 0645192LM2 | 0645192LM25 | 0645192LM31 | 0645192LM43 | 0645192LM72 | 0645192LM82 | 192 | 207 | 2 | 25 |
| 0645320LM1 | 0645320LM2 | 0645320LM25 | 0645320LM31 | 0645320LM43 | 0645320LM72 | 0645320LM82 | 320 | 335 | 2 | 25 |

0657 **NOBB** ALUMINIUM Designer: Viefe Studio **NEW!**

0657 - 1056

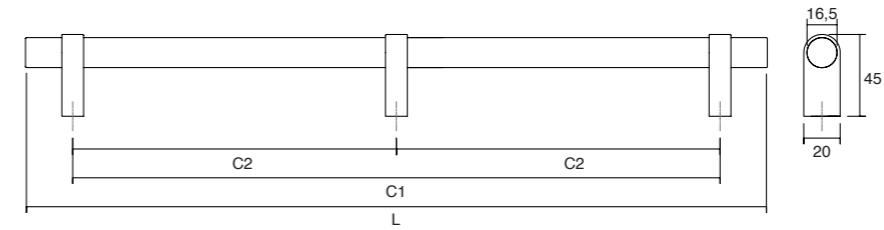

0657 - 192/320

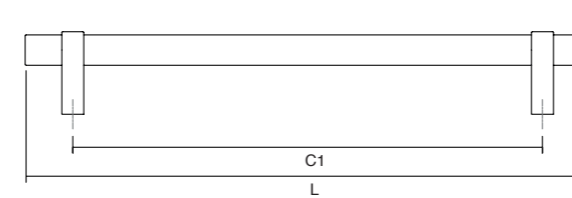

0657 - 052

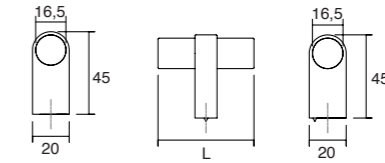

Includes non-twisting tip / Incluye punta anti-giro



| L24 | L618 | L30 | C1 | C2 | L | ↓ | ☐ |
|--|---|---|------|-----|------|---|----|
| Stainless steel look <i>Inox look</i> | Brushed brass cava <i>Latón cava cepillado</i> | Brushed black <i>Negro cepillado</i> | | | | | |
| 0657052L24 | 0657052L618 | 0657052L30 | - | - | 52 | 1 | 25 |
| 0657192L24 | 0657192L618 | 0657192L30 | 192 | - | 244 | 2 | 25 |
| 0657320L24 | 0657320L618 | 0657320L30 | 320 | - | 372 | 2 | 25 |
| 06571056L24 | 06571056L618 | 06571056L30 | 1056 | 528 | 1108 | 3 | 10 |

0655 **RISS big** ALUMINIUM Designer: Kaschkasch **NEW!**

0655 - 480

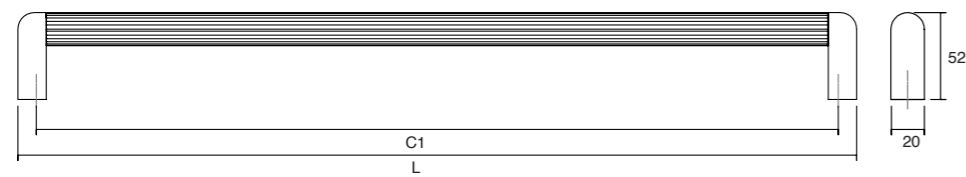

0655 - 960

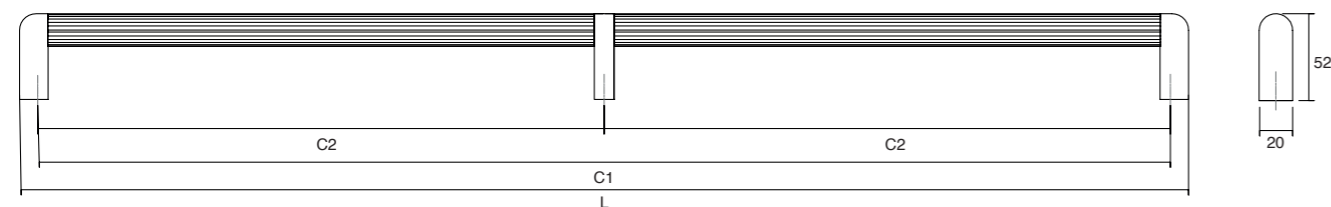

| LM1 | LM2 | LM25 | LM31 | LM43 | LM72 | LM82 | C1 | C2 | L | ↓ | ☐ |
|----------------------------------|---------------------------------|--------------------------------|-------------------------------------|------------------------------------|--------------------------------------|---------------------------------------|-----|-----|-----|---|----|
| Matt white <i>Blanco mate</i> | Matt black <i>Negro mate</i> | Moss grey <i>Gris musgo</i> | Forest green <i>Verde forest</i> | Mocca brown <i>Marrón mocca</i> | Volcano red <i>Rojo volcanico</i> | Midnight blue <i>Azul midnight</i> | | | | | |
| 0655480LM1 | 0655480LM2 | 0655480LM25 | 0655480LM31 | 0655480LM43 | 0655480LM72 | 0655480LM82 | 480 | - | 502 | 2 | 15 |
| 0655960LM1 | 0655960LM2 | 0655960LM25 | 0655960LM31 | 0655960LM43 | 0655960LM72 | 0655960LM82 | 960 | 480 | 982 | 3 | 10 |

0629 / 0662 / 0663 **MOON** ALUMINIUM Designer: Ilja Huber **NEW!**

① Available with one side system
Disponible con sistema de una cara

② Available with back to back system
Disponible con sistema de doble cara

0629 - 384 / 0662 - 384 / 0663 - 384

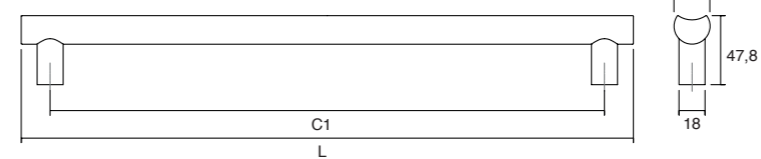

0629 - 1056 / 0662 - 1056 / 0663 - 1056

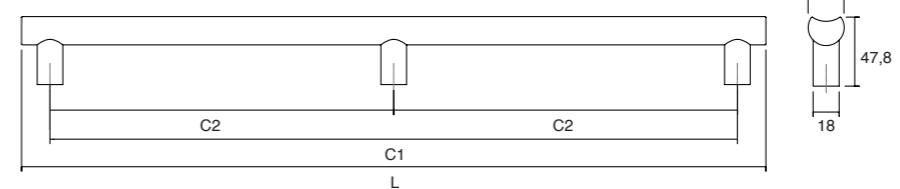

| L24 | L618 | L30 | C1 | C2 | L | ↓ | ☐ |
|--|---|---|------|-----|------|---|----|
| Stainless steel look <i>Inox look</i> | Brushed brass cava <i>Latón cava cepillado</i> | Brushed black <i>Negro cepillado</i> | | | | | |
| 0629384L24 | 0629384L618 | 0629384L30 | 384 | - | 424 | 2 | 15 |
| 06291056L24 | 06291056L618 | 06291056L30 | 1056 | 528 | 1096 | 3 | 10 |
| 0662384L24 | 0662384L618 | 0662384L30 | 384 | - | 424 | 2 | 2 |
| 06621056L24 | 06621056L618 | 06621056L30 | 1056 | 528 | 1096 | 3 | 2 |
| 0663384L24 | 0663384L618 | 0663384L30 | 384 | - | 424 | 2 | 1 |
| 06631056L24 | 06631056L618 | 06631056L30 | 1056 | 528 | 1096 | 3 | 1 |



0658 **DUO mini** ALUMINIUM + WOOD Designer: Ilja Huber **NEW!**

Certified wood
Madera certificada

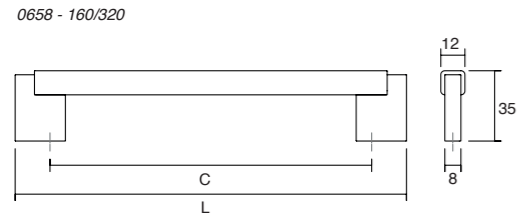

| NM2716 | NM2717 | NM2M2 | C | L | ↓ | ☐ |
|--------------------------------------|---|---|-----|-------|---|----|
| Lava grey + Oak Gris lava + roble | Lava grey + Walnut Gris lava + Nogal | Matt black + Oak matt black lacquered Negro mate + Roble lacado negro mate | | | | |
| 0658160NM2716 | 0658160NM2717 | 0658160NM2M2 | 160 | 194,6 | 2 | 25 |
| 0658320NM2716 | 0658320NM2717 | 0658320NM2M2 | 320 | 354,6 | 2 | 25 |

0659 / 0668 / 0670 **DUO big** ALUMINIUM + WOOD Designer: Ilja Huber **NEW!**

Available with one side system / Disponible con sistema de una cara
Available with back to back system / Disponible con sistema de doble cara
Certified wood / Madera certificada

0659 - 1016 / 0668 - 1016 / 0670 - 1016

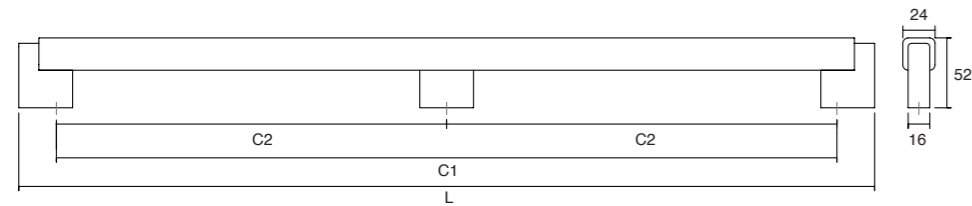

0659 - 536 / 0668 - 536 / 0670 - 536

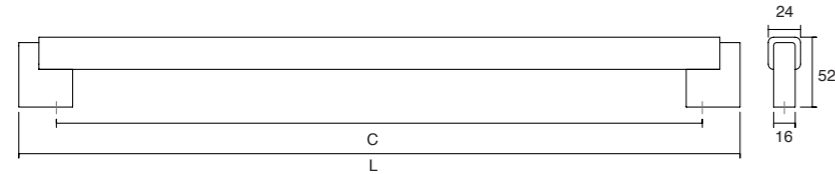

| NM2716 | NM2717 | NM2M2 | C1 | C2 | L | ↓ | ☐ |
|--------------------------------------|---|---|-----|-----|------|---|---|
| Lava grey + Oak Gris lava + roble | Lava grey + Walnut Gris lava + Nogal | Matt black + Oak matt black lacquered Negro mate + Roble lacado negro mate | | | | | |
| 0659480NM2716 | 0659480NM2717 | 0659480NM2M2 | 480 | - | 536 | 2 | 2 |
| 0659960NM2716 | 0659960NM2717 | 0659960NM2M2 | 960 | 480 | 1016 | 3 | 2 |
| 0668480NM2716 | 0668480NM2717 | 0668480NM2M2 | 480 | - | 536 | 2 | 2 |
| 0668960NM2716 | 0668960NM2717 | 0668960NM2M2 | 960 | 480 | 1016 | 3 | 2 |
| 0670480NM2716 | 0670480NM2717 | 0670480NM2M2 | 480 | - | 536 | 2 | 1 |
| 0670960NM2716 | 0670960NM2717 | 0670960NM2M2 | 960 | 480 | 1016 | 3 | 1 |

0664 / 0665 / 0671 **LUV WOOD** WOOD Designer: Kaschkasch **NEW!**

Available with one side system / Disponible con sistema de una cara
Available with back to back system / Disponible con sistema de doble cara
Certified wood / Madera certificada

0664 - 992 / 0665 - 992 / 0671 - 992

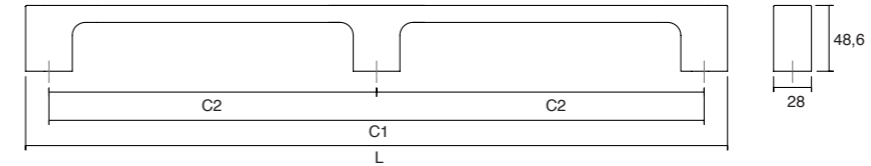

0664 - 384 / 0665 - 384 / 0671 - 384

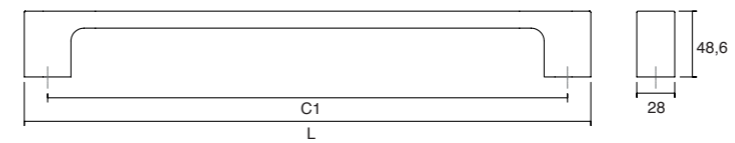

| W16 | W17 | WM2 | C1 | C2 | L | ↓ | ☐ |
|--------------|-----------------|---|-----|-----|--------|---|---|
| Oak Roble | Walnut Nogal | Oak matt black lacquered Roble lacado negro mate | | | | | |
| 0664384W16 | 0664384W17 | 0664384WM2 | 384 | - | 418,5 | 2 | 2 |
| 0664992W16 | 0664992W17 | 0664992WM2 | 992 | 496 | 1026,5 | 3 | 2 |
| 0665384W16 | 0665384W17 | 0665384WM2 | 384 | - | 418,5 | 2 | 2 |
| 0665992W16 | 0665992W17 | 0665992WM2 | 992 | 496 | 1026,5 | 3 | 2 |
| 0671384W16 | 0671384W17 | 0671384WM2 | 384 | - | 418,5 | 2 | 1 |
| 0671992W16 | 0671992W17 | 0671992WM2 | 992 | 496 | 1026,5 | 3 | 1 |



0536 **LUV** ZAMAK Designer: Kaschkasch

0536 - 192 / 320

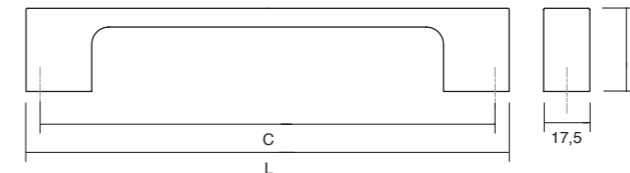

0536 - 017

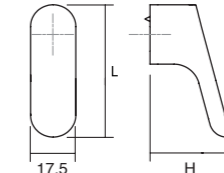

Includes non-twisting tip
Incluye punta anti-giro

| Z23 | Z618 | ZM1 | ZM2 | C | L | H | ↓ | ☐ |
|------------------------------------|--|---------------------------|--------------------------|-----|------|------|---|----|
| Brushed nickel Níquel cepillado | Brushed brass cava Latón cava cepillado | Matt white Blanco mate | Matt black Negro mate | | | | | |
| 0536017Z23 | 0536017Z618 | 0536017ZM1 | 0536017ZM2 | - | 51,2 | 31,1 | 1 | 25 |
| 0536192Z23 | 0536192Z618 | 0536192ZM1 | 0536192ZM2 | 192 | 202 | 30,4 | 2 | 25 |
| 0536320Z23 | 0536320Z618 | 0536320ZM1 | 0536320ZM2 | 320 | 330 | 30,4 | 2 | 25 |

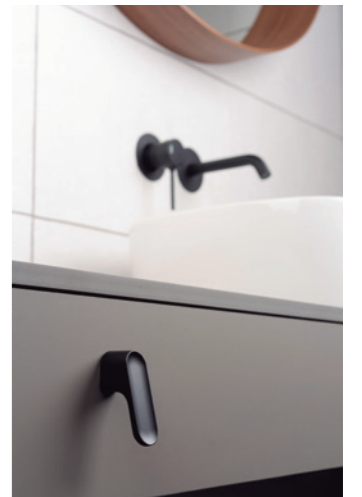

0621 **RILLE mini** ALUMINIUM Designer: Patricia Roig

NEW!



0621 - 160/320

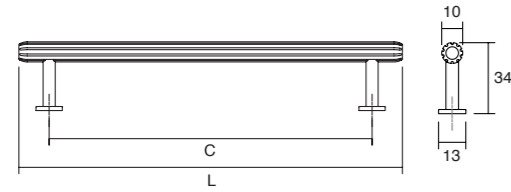

0621 - 055

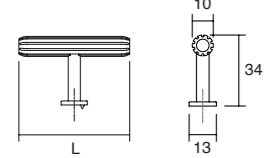

Includes non-twisting tip
Incluye punta anti-giro

| L05 | L24 | L291 | L30 | C | L | ↓ | ☐ |
|----------------------------------|-----------------------------------|----------------------------------|----------------------------------|-----|-----|---|----|
| Polished nickel Níquel brillo | Stainless steel look Inox look | Brushed brass Latón cepillado | Brushed black Negro cepillado | | | | |
| 0621055L05 | 0621055L24 | 0621055L291 | 0621055L30 | - | 55 | 1 | 25 |
| 0621160L05 | 0621160L24 | 0621160L291 | 0621160L30 | 160 | 190 | 2 | 25 |
| 0621320L05 | 0621320L24 | 0621320L291 | 0621320L30 | 320 | 350 | 2 | 25 |

0487 **PURA** ZAMAK Designer: Balutto Associati

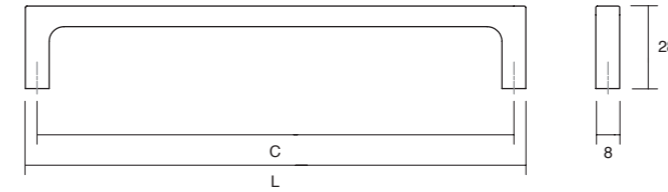

| Z01 | Z03 | Z06 | Z07 | NEW! | NEW! | NEW! | C | L | ↓ | ☐ |
|---------------------------------|---|---------------------------------|--------------------------------|------------------------------------|--|--------------------------|-----|-----|---|----|
| Polished chrome Cromo brillo | Polished titanium black Titanio negro brillo | Polished copper Cobre brillo | Polished brass Latón brillo | Brushed nickel Níquel cepillado | Brushed brass cava Latón cava cepillado | Matt black Negro mate | | | | |
| 0487160Z01 | 0487160Z03 | 0487160Z06 | 0487160Z07 | 0487160Z23 | 0487160Z618 | 0487160ZM2 | 160 | 168 | 2 | 25 |
| NEW! | 0487256Z01 | 0487256Z03 | 0487256Z06 | 0487256Z23 | 0487256Z618 | 0487256ZM2 | 256 | 264 | 2 | 25 |

0528 **RILLE** ALUMINIUM Designer: Patricia Roig



0528 - 160 / 320 / 480

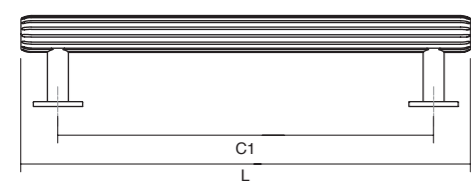

0528 - 055

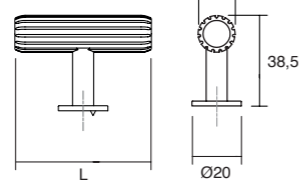

Includes non-twisting tip
Incluye punta anti-giro

0528 - 992

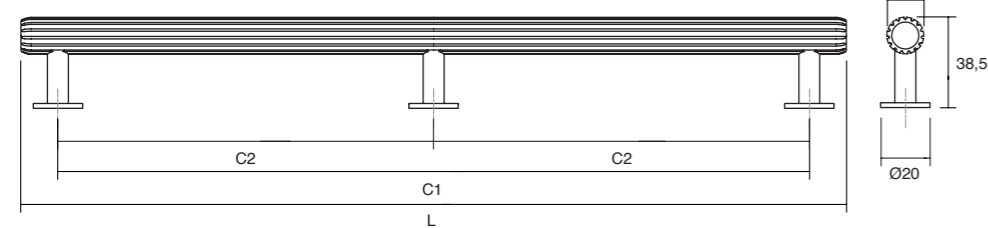

| L24 | L291 | L30 | C1 | C2 | L | ↓ | ☐ |
|-----------------------------------|----------------------------------|----------------------------------|-----|-----|------|---|----|
| Stainless steel look Inox look | Brushed brass Latón cepillado | Brushed black Negro cepillado | | | | | |
| 0528055L24 | 0528055L291 | 0528055L30 | - | - | 55 | 1 | 25 |
| 0528160L24 | 0528160L291 | 0528160L30 | 160 | - | 190 | 2 | 25 |
| 0528320L24 | 0528320L291 | 0528320L30 | 320 | - | 350 | 2 | 25 |
| 0528480L24 | 0528480L291 | 0528480L30 | 480 | - | 510 | 2 | 25 |
| 0528992L24 | 0528992L291 | 0528992L30 | 992 | 496 | 1022 | 3 | 15 |

0590 **BELT** ZAMAK Designer: Kaschkasch

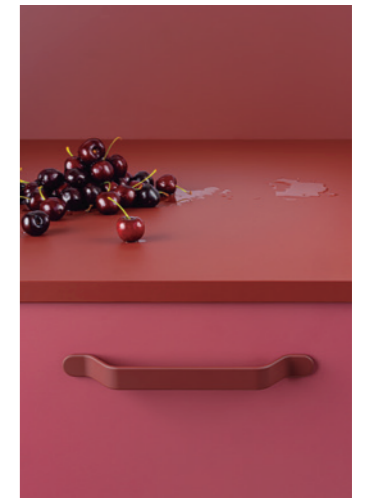

0590 - 160

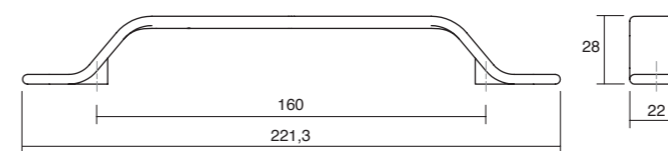

0590 - 022

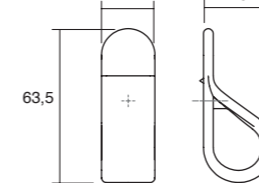

Includes non-twisting tip / Incluye punta anti-giro

| ZM1 | ZM2 | ZM25 | ZM31 | ZM43 | ZM72 | ↓ | ☐ |
|---------------------------|--------------------------|-------------------------|------------------------------|-----------------------------|-----------------------------|---|----|
| Matt white Blanco mate | Matt black Negro mate | Moss grey Gris musgo | Forest green Verde forest | Mocca brown Marrón mocca | Volcano red Rojo volcano | | |
| 0590022ZM1 | 0590022ZM2 | 0590022ZM25 | 0590022ZM31 | 0590022ZM43 | 0590022ZM72 | 1 | 25 |
| 0590160ZM1 | 0590160ZM2 | 0590160ZM25 | 0590160ZM31 | 0590160ZM43 | 0590160ZM72 | 2 | 25 |

0597 **PLIÉ**

ZAMAK

Designer: Teruel & Paré

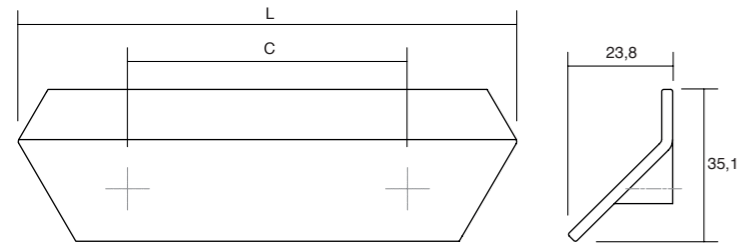

| ZM2 | ZM23 | ZM41 | C | L | ↓ | ☐ |
|---------------------------------|---------------------------------|------------------------------------|-----|-----|---|----|
| Matt black <i>Negro mate</i> | Metal grey <i>Gris metal</i> | Metal brown <i>Marrón metal</i> | | | | |
| 0597064ZM2 | 0597064ZM23 | 0597064ZM41 | 64 | 114 | 2 | 25 |
| 0597160ZM2 | 0597160ZM23 | 0597160ZM41 | 160 | 210 | 2 | 25 |

0591 **ETO**

ALUMINIUM + WOOD

Designer: Kaschkasch

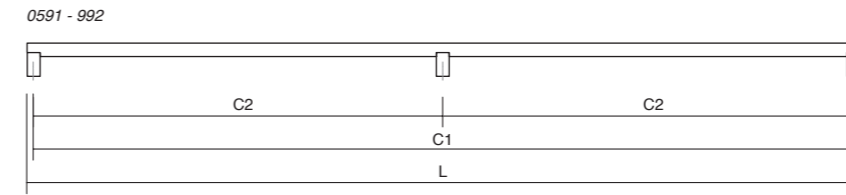
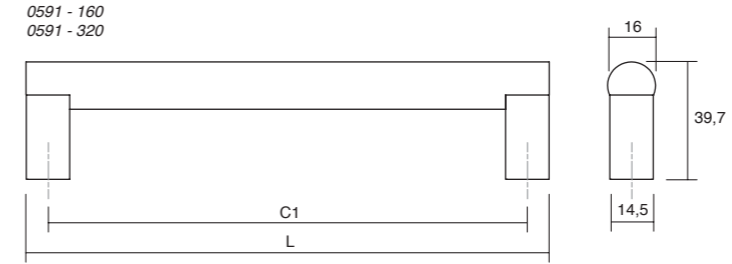

| NM2716 | NM2717 | NM2M2 | C1 | C2 | L | ↓ | ☐ |
|---|--|---|-----|-----|--------|---|----|
| Lava grey + Oak <i>Gris lava + roble</i> | Lava grey + Walnut <i>Gris lava + Nogal</i> | Matt black + Ash matt black lacquered <i>Negro mate + Fresno lacado negro mate</i> | | | | | |
| 0591160NM2716 | 0591160NM2717 | 0591160NM2M2 | 160 | - | 174,6 | 2 | 25 |
| 0591320NM2716 | 0591320NM2717 | 0591320NM2M2 | 320 | - | 334,6 | 2 | 25 |
| 0591992NM2716 | 0591992NM2717 | 0591992NM2M2 | 992 | 496 | 1006,6 | 3 | 15 |

0600 **WING**

ALUMINIUM

Designer: Alexis Vivet

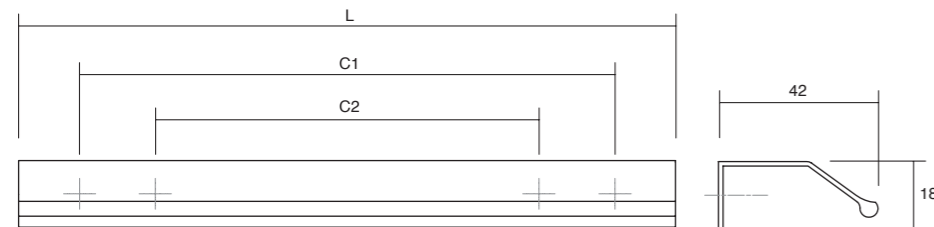

| L24 | L30 | L613 | L618 | C1 | C2 | L | ↓ | ☐ |
|--|---|---|---|------|-----|------|---|----|
| Stainless steel look <i>Inox look</i> | Brushed black <i>Negro cepillado</i> | Antique bronze <i>Bronce antiguo</i> | Brushed brass cava <i>Latón cava cepillado</i> | | | | | |
| 0600064L24 | 0600064L30 | 0600064L613 | 0600064L618 | 64 | - | 100 | 2 | 25 |
| 0600128L24 | 0600128L30 | 0600128L613 | 0600128L618 | 128 | - | 200 | 2 | 25 |
| 0600256L24 | 0600256L30 | 0600256L613 | 0600256L618 | 256 | - | 350 | 2 | 25 |
| 06001120L24 | 06001120L30 | 06001120L613 | 06001120L618 | 1120 | 384 | 1200 | 4 | 15 |



0610 **FLAPP Aluminium**

ALUMINIUM

Designer: Frank Person

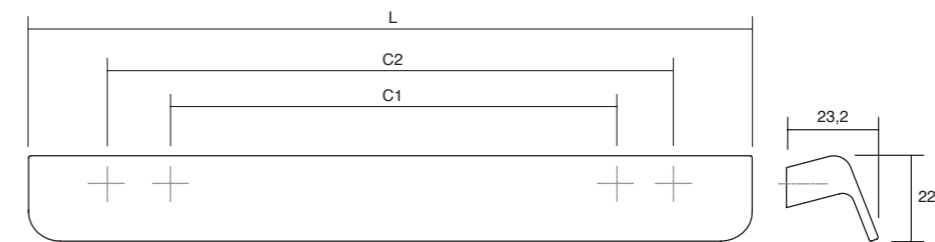

| L24 | L30 | L618 | C1 | C2 | L | ↓ | ☐ |
|--|---|---|-----|------|------|---|----|
| Stainless steel look <i>Inox look</i> | Brushed black <i>Negro cepillado</i> | Brushed brass cava <i>Latón cava cepillado</i> | | | | | |
| 0610032L24 | 0610032L30 | 0610032L618 | 32 | - | 70 | 2 | 25 |
| 0610160L24 | 0610160L30 | 0610160L618 | 128 | 160 | 200 | 4 | 25 |
| 0610256L24 | 0610256L30 | 0610256L618 | 256 | - | 350 | 2 | 25 |
| 06101056L24 | 06101056L30 | 06101056L618 | 416 | 1056 | 1100 | 4 | 15 |



0613 **FLAPP Wood**

WOOD

Designer: Frank Person

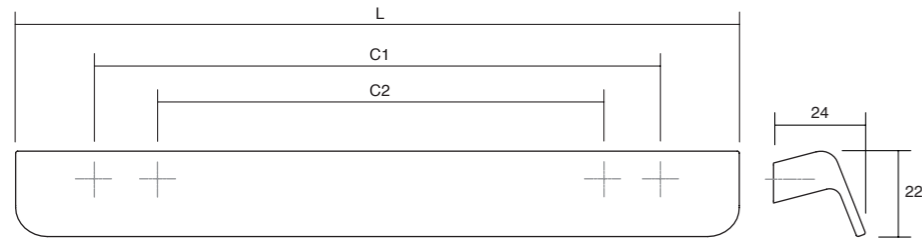

| W16 Oak Roble | W17 Walnut Nogal | NEW! W00 Oak raw Roble crudo | C1 | C2 | L | ↓ | ☐ |
|---------------------|------------------------|--|------|-----|------|---|----|
| 0613032W16 | 0613032W17 | 0613032W00 | 32 | - | 70 | 2 | 25 |
| 0613160W16 | 0613160W17 | 0613160W00 | 160 | - | 200 | 2 | 25 |
| 06131056W16 | 06131056W17 | 06131056W00 | 1056 | 416 | 1100 | 4 | 15 |

0601 **OH! Wood**

WOOD

Designer: Alexis Vivet

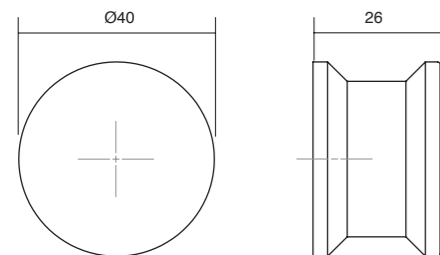

| W16 Oak Roble | W17 Walnut Nogal | WM2 Ash matt black lacquered Fresno lacado negro mate | ↓ | ☐ |
|---------------------|------------------------|---|---|----|
| 0601040W16 | 0601040W17 | 0601040WM2 | 1 | 25 |

0601 **OH! Zamak**

ZAMAK

Designer: Alexis Vivet

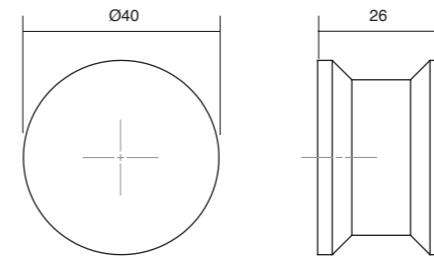
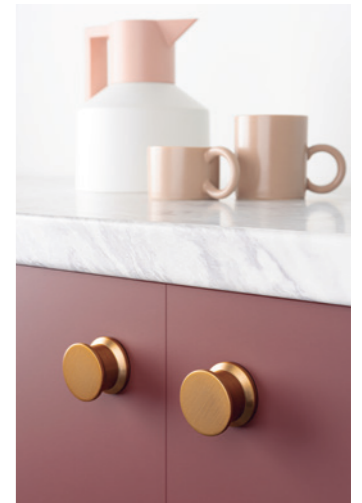

| Z23 Brushed nickel Níquel cepillado | Z618 Brushed brass cava Latón cava cepillado | ZM2 Matt black Negro mate | ↓ | ☐ |
|---|--|---------------------------------|---|----|
| 0601040Z23 | 0601040Z618 | 0601040ZM2 | 1 | 25 |

0602 **VALLEY**

ZAMAK

Designer: Alexis Vivet

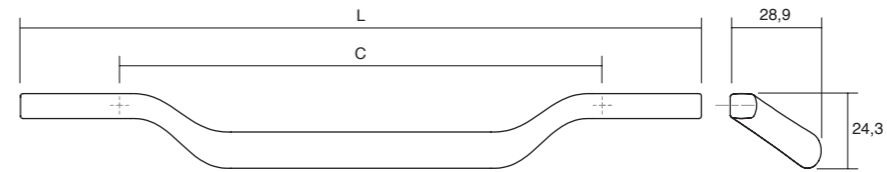
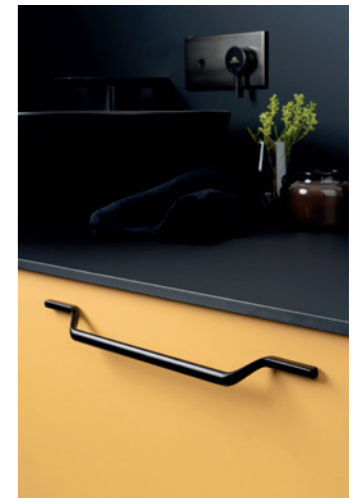

| Z03 Polished titanium black Titanio negro brillo | Z07 Polished brass Latón brillo | Z618 Brushed brass cava Latón cava cepillado | ZM2 Matt black Negro mate | C | L | ↓ | ☐ |
|--|---------------------------------------|--|---------------------------------|-----|-----|---|----|
| 0602160Z03 | 0602160Z07 | 0602160Z618 | 0602160ZM2 | 160 | 223 | 2 | 25 |
| 0602256Z03 | 0602256Z07 | 0602256Z618 | 0602256ZM2 | 256 | 330 | 2 | 25 |

0604 **PRISMA**

ZAMAK

Designer: Alexis Vivet

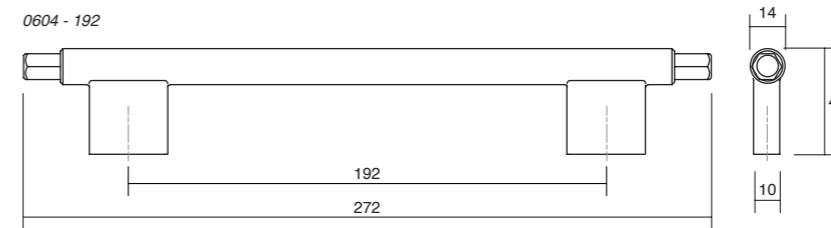

| ZM2 Matt black Negro mate | Z623 Rustic brass Latón rústico | ↓ | ☐ |
|---------------------------------|---------------------------------------|---|----|
| 0604078ZM2 | 0604078Z623 | 1 | 25 |
| 0604192ZM2 | 0604192Z623 | 2 | 15 |

Includes non-twisting tip
Incluye punta anti-giro

0608 **QUART Mini** ZAMAK Designer: Frank Person

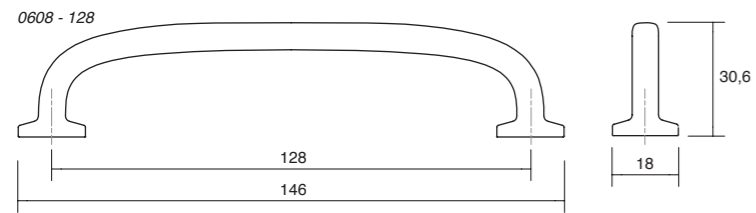

0608 - 026

| Z618 | Z623 | ZM2 | | |
|----------------------|---------------|------------|---|----|
| Brushed brass cava | Rustic brass | Matt black | ↓ | 📦 |
| Latón cava cepillado | Latón rústico | Negro mate | | |
| 0608026Z618 | 0608026Z623 | 0608026ZM2 | 1 | 25 |
| 0608128Z618 | 0608128Z623 | 0608128ZM2 | 2 | 25 |

Includes non-twisting tip
Incluye punta anti-giro



0530 **DISC** WOOD Designer: Balutto Associati

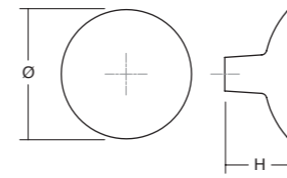

| W16 | W17 | WM2 | Ø | H | ↓ | 📦 |
|------------|------------|--------------------------|----|------|---|----|
| Oak | Walnut | Ash matt black lacquered | | | | |
| Roble | Nogal | Fresno lacado negro mate | | | | |
| 0530038W16 | 0530038W17 | 0530038WM2 | 38 | 20,4 | 1 | 25 |
| 0530050W16 | 0530050W17 | 0530050WM2 | 50 | 27 | 1 | 25 |



0616 **QUART Big** ZAMAK Designer: Frank Person

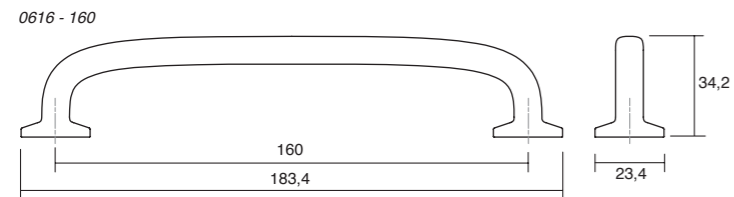

0616 - 034

| Z618 | Z623 | ZM2 | | |
|----------------------|---------------|------------|---|----|
| Brushed brass cava | Rustic brass | Matt black | ↓ | 📦 |
| Latón cava cepillado | Latón rústico | Negro mate | | |
| 0616034Z618 | 0616034Z623 | 0616034ZM2 | 1 | 25 |
| 0616160Z618 | 0616160Z623 | 0616160ZM2 | 2 | 25 |

Includes non-twisting tip
Incluye punta anti-giro



0530 **DISC** ZAMAK Designer: Balutto Associati

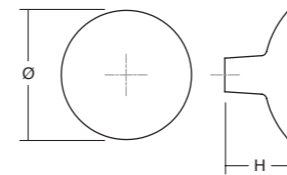

| Z23 | Z618 | ZM1 | ZM2 | Ø | H | ↓ | 📦 |
|------------------|----------------------|-------------|------------|----|------|---|----|
| Brushed nickel | Brushed brass cava | Matt white | Matt black | | | | |
| Níquel cepillado | Latón cava cepillado | Blanco mate | Negro mate | | | | |
| 0530038Z23 | 0530038Z618 | 0530038ZM1 | 0530038ZM2 | 38 | 20,4 | 1 | 25 |
| 0530050Z23 | 0530050Z618 | 0530050ZM1 | 0530050ZM2 | 50 | 27 | 1 | 25 |

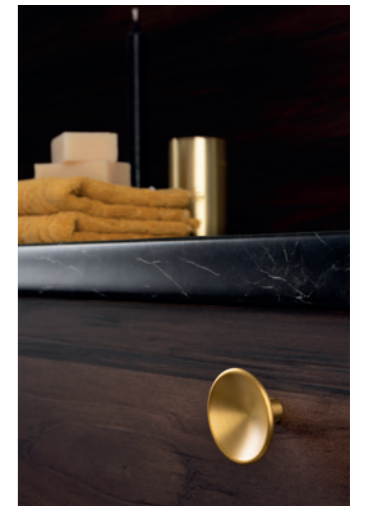

0614 **EQUIS** ZAMAK Designer: Patricia Roig

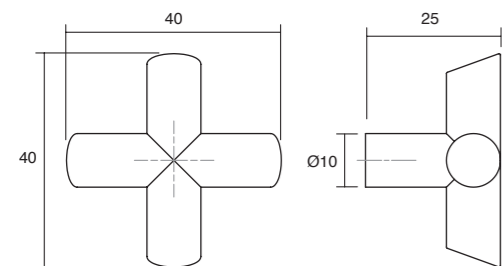

| Z01 | Z03 | Z06 | Z07 | ZM1 | ZM2 | | |
|-----------------|-------------------------|-----------------|----------------|-------------|------------|---|----|
| Polished chrome | Polished titanium black | Polished copper | Polished brass | Matt white | Matt black | ↓ | 📦 |
| Cromo brillo | Titanio negro brillo | Cobre brillo | Latón brillo | Blanco mate | Negro mate | | |
| 0614040Z01 | 0614040Z03 | 0614040Z06 | 0614040Z07 | 0614040ZM1 | 0614040ZM2 | 1 | 25 |



0538 **CONIC** WOOD Designer: Kaschkasch

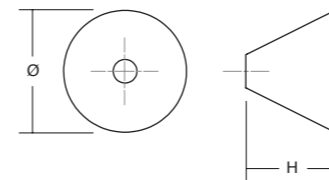

| W16 | W17 | WM2 | Ø | H | ↓ | 📦 |
|------------|------------|--------------------------|------|----|---|----|
| Oak | Walnut | Ash matt black lacquered | | | | |
| Roble | Nogal | Fresno lacado negro mate | | | | |
| 0538029W16 | 0538029W17 | 0538029WM2 | 29,4 | 22 | 1 | 25 |
| 0538043W16 | 0538043W17 | 0538043WM2 | 43 | 25 | 1 | 25 |

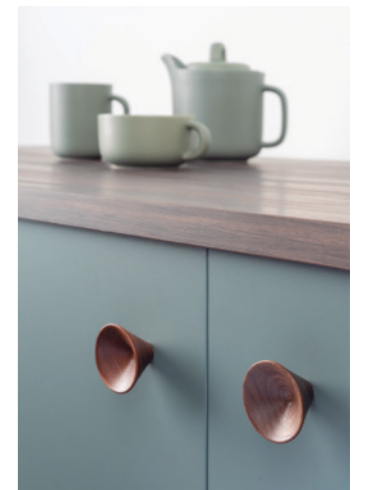

0538 **CONIC** ZAMAK Designer: Kaschkasch

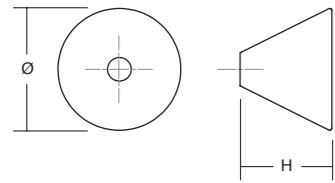

| ZM1 | ZM2 | ZM25 | Ø | H | ↓ | ☐ |
|----------------------------------|---------------------------------|--------------------------------|------|----|---|----|
| Matt white <i>Blanco mate</i> | Matt black <i>Negro mate</i> | Moss grey <i>Gris musgo</i> | | | | |
| 0538029ZM1 | 0538029ZM2 | 0538029ZM25 | 29,4 | 22 | 1 | 25 |
| 0538043ZM1 | 0538043ZM2 | 0538043ZM25 | 43 | 25 | 1 | 25 |



0552 **RIM** ZAMAK Designer: Bernat Lonch

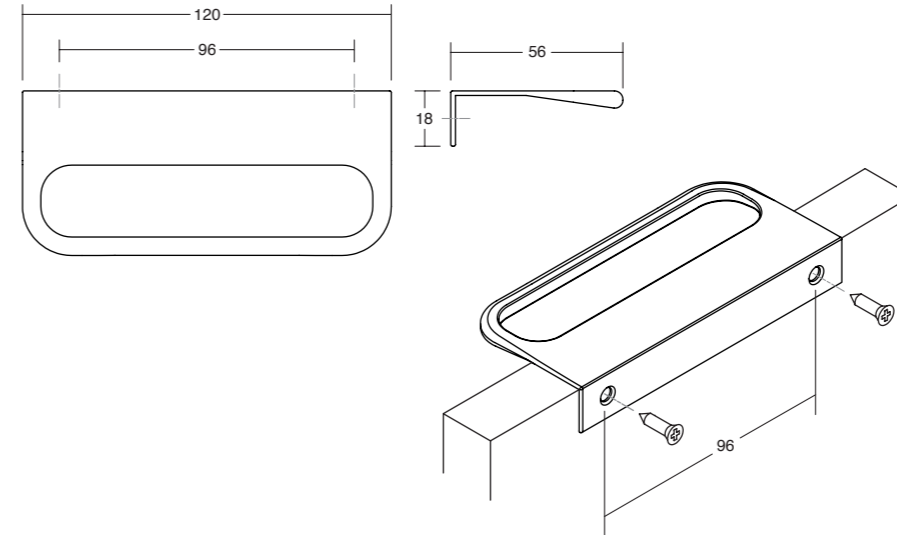

0556 **DIPO** ZAMAK Designer: Bernat Lonch

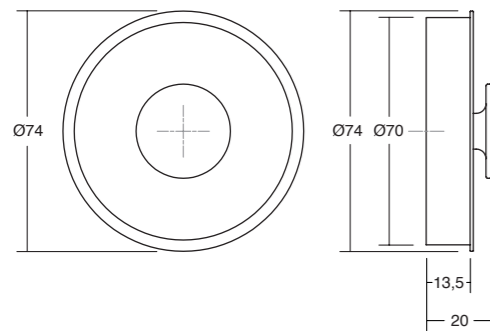

| ZM1 | ZM2 | ZM25 | ↓ | ☐ |
|----------------------------------|---------------------------------|--------------------------------|---|----|
| Matt white <i>Blanco mate</i> | Matt black <i>Negro mate</i> | Moss grey <i>Gris musgo</i> | | |
| 0556070ZM1 | 0556070ZM2 | 0556070ZM25 | 1 | 25 |



| Z23 | Z618 | ZM1 | ZM2 | ZM25 | ↓ | ☐ |
|---|---|----------------------------------|---------------------------------|--------------------------------|---|----|
| Brushed nickel <i>Níquel cepillado</i> | Brushed brass cava <i>Latón cava cepillado</i> | Matt white <i>Blanco mate</i> | Matt black <i>Negro mate</i> | Moss grey <i>Gris musgo</i> | | |
| 0552096Z23 | 0552096Z618 | 0552096ZM1 | 0552096ZM2 | 0552096ZM25 | 2 | 25 |

0553 **OTO** ZAMAK Designer: Bernat Lonch

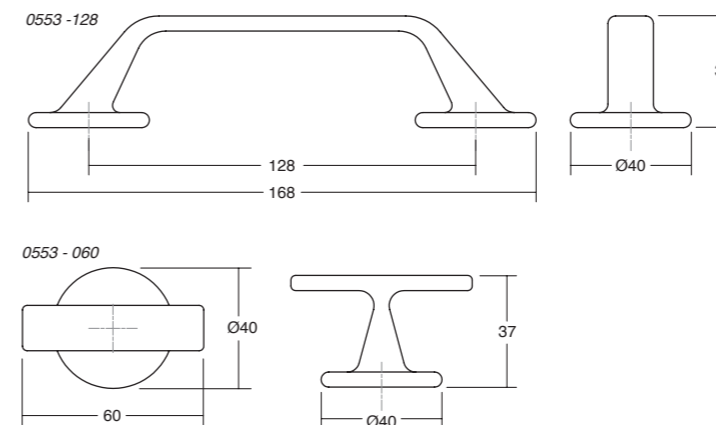

0543 **SOFT** ZAMAK Designer: Uli Budde

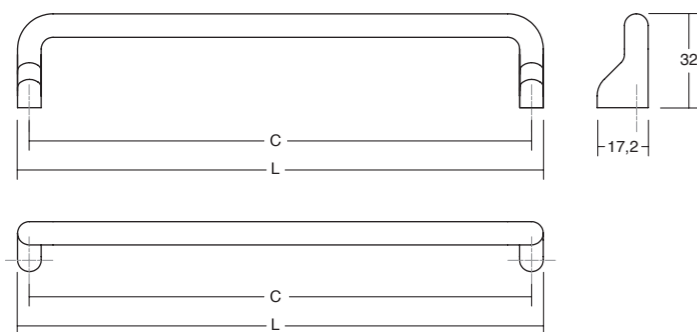

| ZM1 | ZM2 | ZM25 | C | L | ↓ | ☐ |
|----------------------------------|---------------------------------|--------------------------------|-----|-----|---|----|
| Matt white <i>Blanco mate</i> | Matt black <i>Negro mate</i> | Moss grey <i>Gris musgo</i> | | | | |
| 0543032ZM1 | 0543032ZM2 | 0543032ZM25 | 32 | 40 | 2 | 25 |
| 0543192ZM1 | 0543192ZM2 | 0543192ZM25 | 192 | 200 | 2 | 25 |
| 0543320ZM1 | 0543320ZM2 | 0543320ZM25 | 320 | 328 | 2 | 25 |



| ZM22 | ↓ | ☐ |
|--|---|----|
| Black textured <i>Negro texturizado</i> | | |
| 0553060ZM22 | 1 | 25 |
| 0553128ZM22 | 2 | 25 |

0542 **FOLD** ZAMAK Designer: Teruel & Paré

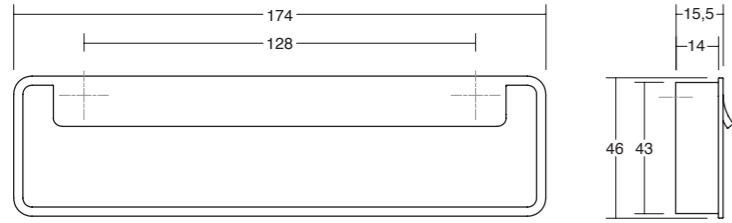

| Z23 | Z618 | ZM1 | ZM2 | ↓ | ☐ |
|-------------------------|-----------------------------|--------------------|-------------------|---|----|
| Brushed nickel | Brushed brass cava | Matt white | Matt black | | |
| <i>Níquel cepillado</i> | <i>Latón cava cepillado</i> | <i>Blanco mate</i> | <i>Negro mate</i> | | |
| 0542128Z23 | 0542128Z618 | 0542128ZM1 | 0542128ZM2 | 2 | 25 |

0588 **ARPA PLATE** ALUMINIUM Designer: Viefe Studio

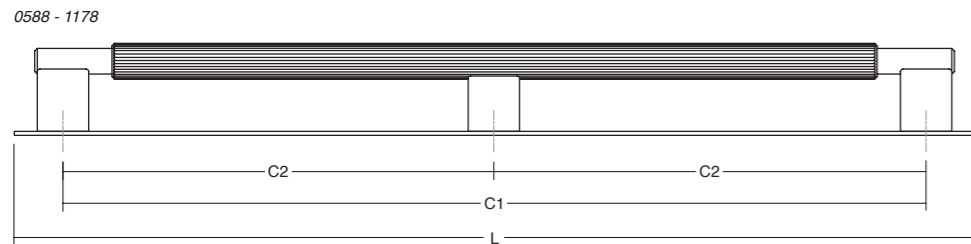
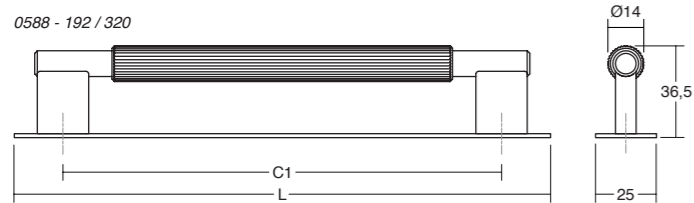
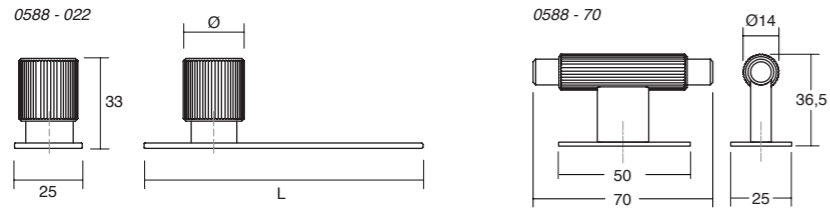

| L24 | L291 | L30 | L623 | C1 | C2 | L | Ø | ↓ | ☐ |
|----------------------|------------------------|------------------------|----------------------|------|-----|------|----|---|----|
| Stainless steel look | Brushed brass | Brushed black | Antique brass | | | | | | |
| <i>Inox look</i> | <i>Latón cepillado</i> | <i>Negro cepillado</i> | <i>Latón antiguo</i> | | | | | | |
| 0588022L24 | 0588022L291 | 0588022L30 | 0588022L623 | - | - | 100 | 22 | 1 | 25 |
| 0588070L24 | 0588070L291 | 0588070L30 | 0588070L623 | - | - | 70 | - | 1 | 25 |
| 0588192L24 | 0588192L291 | 0588192L30 | 0588192L623 | 192 | - | 230 | - | 2 | 25 |
| 0588320L24 | 0588320L291 | 0588320L30 | - | 320 | - | 358 | - | 2 | 25 |
| 05881178L24 | 05881178L291 | 05881178L30 | - | 1178 | 589 | 1216 | - | 3 | 10 |

0583 **ARPA** ALUMINIUM Designer: Viefe Studio

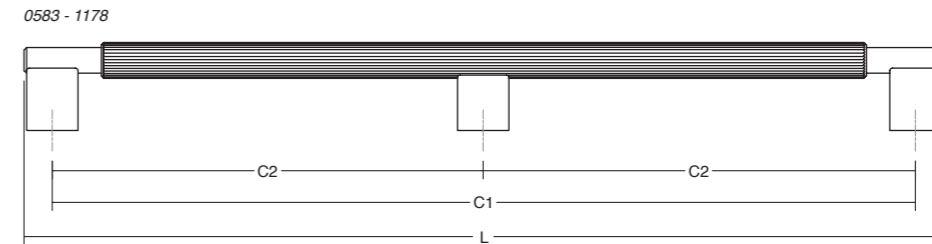
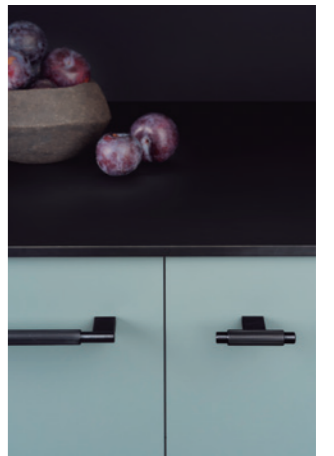
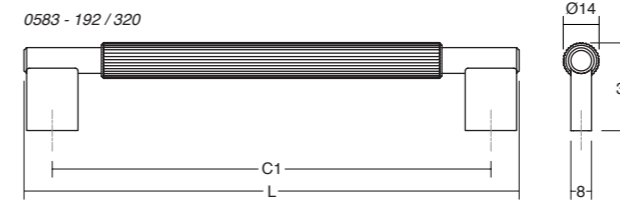
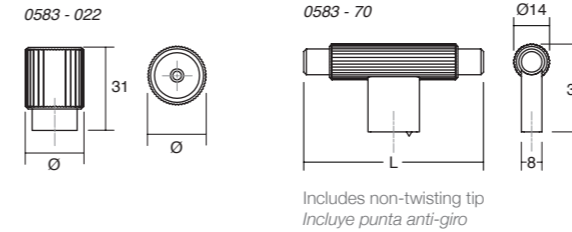

| L24 | L291 | L30 | L623 | C1 | C2 | L | Ø | ↓ | ☐ |
|---------------------|------------------------|------------------------|----------------------|------|-----|------|----|---|----|
| Stainless stl. look | Brushed brass | Brushed black | Rustic brass | | | | | | |
| <i>Inox look</i> | <i>Latón cepillado</i> | <i>Negro cepillado</i> | <i>Latón rústico</i> | | | | | | |
| 0583022L24 | 0583022L291 | 0583022L30 | 0583022L623 | - | - | - | 22 | 1 | 25 |
| 0583070L24 | 0583070L291 | 0583070L30 | 0583070L623 | - | - | 70 | - | 1 | 25 |
| 0583192L24 | 0583192L291 | 0583192L30 | 0583192L623 | 192 | - | 214 | - | 2 | 25 |
| 0583320L24 | 0583320L291 | 0583320L30 | - | 320 | - | 342 | - | 2 | 25 |
| 05831178L24 | 05831178L291 | 05831178L30 | - | 1178 | 589 | 1200 | - | 3 | 10 |

0495 **FLOID** ZAMAK Designer: Frank Person

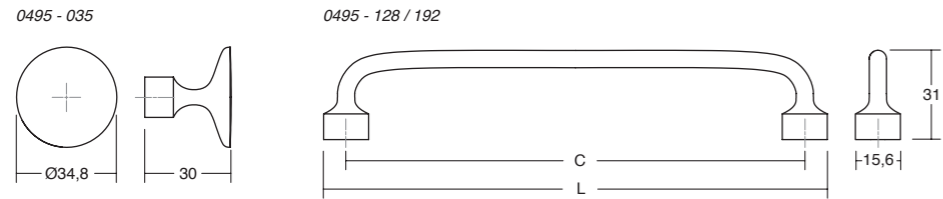

| Z28 | Z610 | Z614 | ZM2 | C | L | ↓ | ☐ |
|---------------|-------------|---------------|------------|-----|-------|---|----|
| Brushed gold | Pewter | Antique brass | Matt black | | | | |
| Oro cepillado | Peltre | Latón antiguo | Negro mate | | | | |
| 0495035Z28 | 0495035Z610 | 0495035Z614 | 0495035ZM2 | - | - | 1 | 25 |
| 0495128Z28 | 0495128Z610 | 0495128Z614 | 0495128ZM2 | 128 | 143,6 | 2 | 25 |
| 0495192Z28 | 0495192Z610 | 0495192Z614 | 0495192ZM2 | 192 | 207,6 | 2 | 25 |



0127 **JEY** ALUMINIUM Designer: Viefe Studio

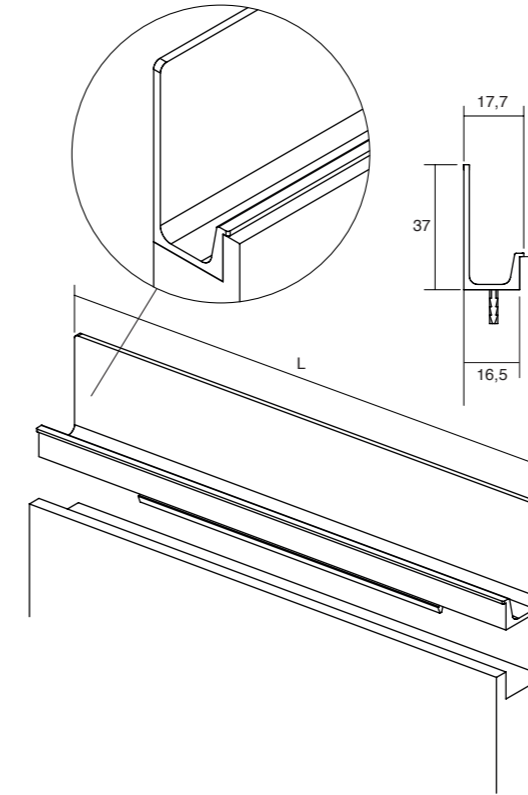

| L24 | L618 | LM1 | LM2 | L | ☐ |
|----------------------|----------------------|-------------|-------------|------|------|
| Stainless steel look | Brushed brass cava | Matt white | Matt black | | |
| Inox look | Latón cava cepillado | Blanco mate | Negro mate | | |
| 0127147L24 | 0127147L618 | 0127147LM1 | 0127147LM2 | 147 | 15 |
| 0127197L24 | 0127197L618 | 0127197LM1 | 0127197LM2 | 197 | 15 |
| 0127247L24 | 0127247L618 | 0127247LM1 | 0127247LM2 | 247 | 15 |
| 0127297L24 | 0127297L618 | 0127297LM1 | 0127297LM2 | 297 | 15 |
| 0127347L24 | 0127347L618 | 0127347LM1 | 0127347LM2 | 347 | 15 |
| 0127397L24 | 0127397L618 | 0127397LM1 | 0127397LM2 | 397 | 15 |
| 0127447L24 | 0127447L618 | 0127447LM1 | 0127447LM2 | 447 | 10 |
| 0127497L24 | 0127497L618 | 0127497LM1 | 0127497LM2 | 497 | 10 |
| 0127597L24 | 0127597L618 | 0127597LM1 | 0127597LM2 | 597 | 10 |
| 0127697L24 | 0127697L618 | 0127697LM1 | 0127697LM2 | 697 | 10 |
| 0127797L24 | 0127797L618 | 0127797LM1 | 0127797LM2 | 797 | 10 |
| 0127897L24 | 0127897L618 | 0127897LM1 | 0127897LM2 | 897 | 5 |
| 0127997L24 | 0127997L618 | 0127997LM1 | 0127997LM2 | 997 | 5 |
| 01271197L24 | 01271197L618 | 01271197LM1 | 01271197LM2 | 1197 | 5 |
| - | - | 01273000LM1 | 01273000LM2 | 3000 | 15 * |

*Available only in M1 and M2 finishes. Three metre profiles are delivered according to the units of the original packaging and cannot be sold separately. / Disponible solo en los acabados M1 y M2. Las barras de tres metros se sirven según las cantidades del embalaje original y no se pueden servir por separado.

0496 **BAU** ZAMAK Designer: Patricia Roig

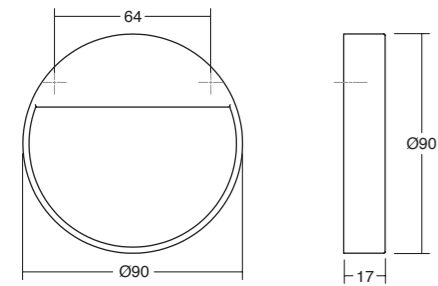

| Z23 | Z28 | ZM2 | ↓ | ☐ |
|------------------|---------------|------------|---|----|
| Brushed nickel | Brushed gold | Matt black | | |
| Níquel cepillado | Oro cepillado | Negro mate | | |
| 0496064Z23 | 0496064Z28 | 0496064ZM2 | 2 | 25 |

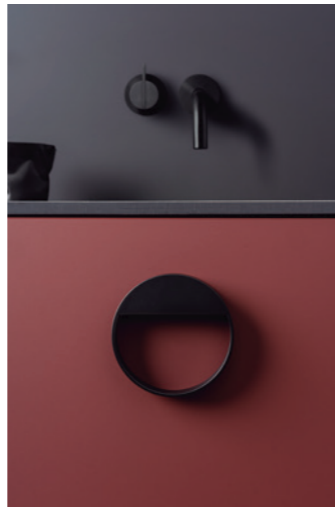

0163 **JEY2** ALUMINIUM Designer: Viefe Studio

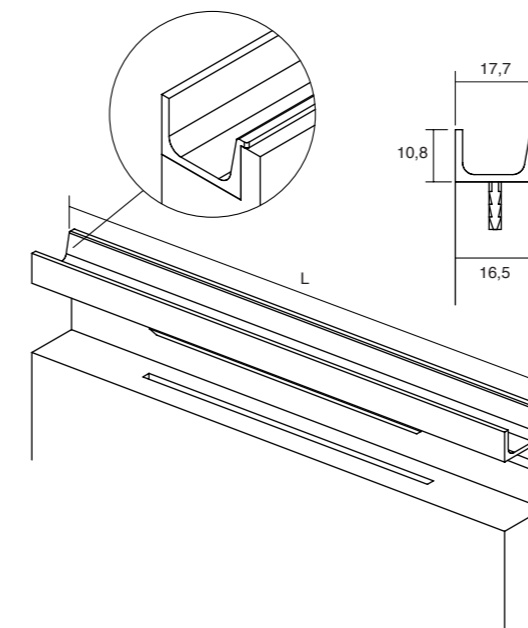

| L24 | L618 | LM1 | LM2 | L | ☐ |
|----------------------|----------------------|-------------|-------------|------|------|
| Stainless steel look | Brushed brass cava | Matt white | Matt black | | |
| Inox look | Latón cava cepillado | Blanco mate | Negro mate | | |
| 0163147L24 | 0163147L618 | 0163147LM1 | 0163147LM2 | 147 | 15 |
| 0163197L24 | 0163197L618 | 0163197LM1 | 0163197LM2 | 197 | 15 |
| 0163247L24 | 0163247L618 | 0163247LM1 | 0163247LM2 | 247 | 15 |
| 0163297L24 | 0163297L618 | 0163297LM1 | 0163297LM2 | 297 | 15 |
| 0163347L24 | 0163347L618 | 0163347LM1 | 0163347LM2 | 347 | 15 |
| 0163397L24 | 0163397L618 | 0163397LM1 | 0163397LM2 | 397 | 15 |
| 0163447L24 | 0163447L618 | 0163447LM1 | 0163447LM2 | 447 | 10 |
| 0163497L24 | 0163497L618 | 0163497LM1 | 0163497LM2 | 497 | 10 |
| 0163597L24 | 0163597L618 | 0163597LM1 | 0163597LM2 | 597 | 10 |
| 0163697L24 | 0163697L618 | 0163697LM1 | 0163697LM2 | 697 | 10 |
| 0163797L24 | 0163797L618 | 0163797LM1 | 0163797LM2 | 797 | 10 |
| 0163897L24 | 0163897L618 | 0163897LM1 | 0163897LM2 | 897 | 5 |
| 0163997L24 | 0163997L618 | 0163997LM1 | 0163997LM2 | 997 | 5 |
| 01631197L24 | 01631197L618 | 01631197LM1 | 01631197LM2 | 1197 | 5 |
| - | - | 01633000LM1 | 01633000LM2 | 3000 | 15 * |

*Available only in M1 and M2 finishes. Three metre profiles are delivered according to the units of the original packaging and cannot be sold separately. / Disponible solo en los acabados M1 y M2. Las barras de tres metros se sirven según las cantidades del embalaje original y no se pueden servir por separado.

0168 **COMO** ZAMAK Designer: Viefe Studio

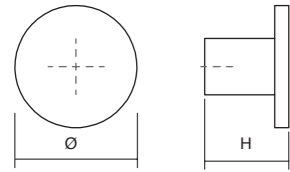

| Z01 | Z03 | Z06 | Z07 | Z11 | Z23 | Z26 | Z28 | ZM1 | ZM2 | Ø | H | ↓ | ☐ |
|---------------------|-----------------------------|---------------------|---------------------|-------------------|-------------------------|------------------------|----------------------|--------------------|-------------------|----|----|---|----|
| Polished chrome | Polished titanium black | Polished copper | Polished brass | Matt chrome | Brushed nickel | Brushed copper | Brushed gold | Matt white | Matt black | | | | |
| <i>Cromo brillo</i> | <i>Titanio negro brillo</i> | <i>Cobre brillo</i> | <i>Latón brillo</i> | <i>Cromo mate</i> | <i>Níquel cepillado</i> | <i>Cobre cepillado</i> | <i>Oro cepillado</i> | <i>Blanco mate</i> | <i>Negro mate</i> | | | | |
| 0168026Z01 | 0168026Z03 | 0168026Z06 | 0168026Z07 | 0168026Z11 | 0168026Z23 | 0168026Z26 | 0168026Z28 | 0168026ZM1 | 0168026ZM2 | 26 | 18 | 1 | 25 |
| 0168041Z01 | 0168041Z03 | 0168041Z06 | 0168041Z07 | 0168041Z11 | 0168041Z23 | 0168041Z26 | 0168041Z28 | 0168041ZM1 | 0168041ZM2 | 41 | 25 | 1 | 25 |

0497 **DIABOLO** ALUMINIUM Designer: Frank Person

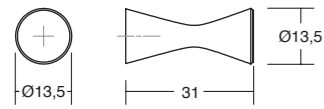

| L24 | L291 | L30 | L31 | ↓ | ☐ |
|----------------------|------------------------|------------------------|-----------------------|---|----|
| Stainless steel look | Brushed brass | Brushed black | Brushed grey | | |
| <i>Inox look</i> | <i>Latón cepillado</i> | <i>Negro cepillado</i> | <i>Gris cepillado</i> | | |
| 0497014L24 | 0497014L291 | 0497014L30 | 0497014L31 | 1 | 25 |

0518 **WAY** ALUMINIUM Designer: Viefe Studio

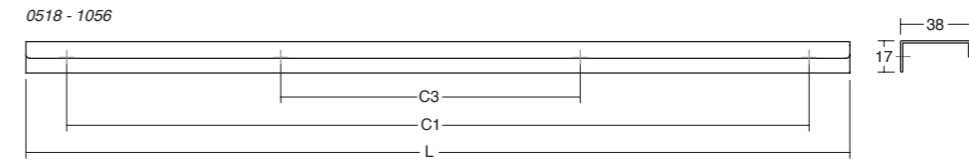
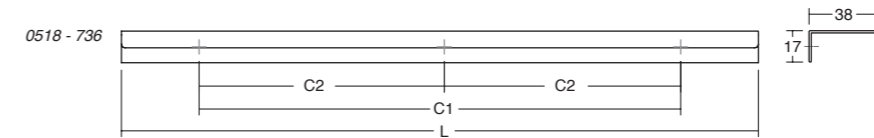
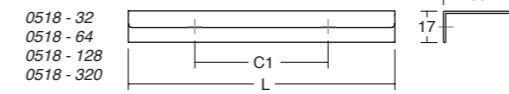

| L04 | L09 | L24 | L29 | LM1 | C1 | C2 | C3 | L | ↓ | ☐ |
|-----------------------|-------------------|----------------------|-------------------------------|--------------------|------|-----|-----|------|---|----|
| Anodized matt | Matt black | Stainless steel look | Brushed dark brass | Matt White | | | | | | |
| <i>Anodizado mate</i> | <i>Negro mate</i> | <i>Inox look</i> | <i>Latón oscuro cepillado</i> | <i>Blanco mate</i> | | | | | | |
| 0518032L04 | 0518032L09 | 0518032L24 | 0518032L29 | 0518032LM1 | 32 | - | - | 50 | 2 | 25 |
| 0518064L04 | 0518064L09 | 0518064L24 | 0518064L29 | 0518064LM1 | 64 | - | - | 100 | 2 | 25 |
| 0518128L04 | 0518128L09 | 0518128L24 | 0518128L29 | 0518128LM1 | 128 | - | - | 200 | 2 | 25 |
| 0518320L04 | 0518320L09 | 0518320L24 | 0518320L29 | 0518320LM1 | 320 | - | - | 400 | 2 | 25 |
| 0518736L04 | 0518736L09 | 0518736L24 | 0518736L29 | 0518736LM1 | 736 | 368 | - | 800 | 3 | 25 |
| 05181056L04 | 05181056L09 | 05181056L24 | 05181056L29 | 05181056LM1 | 1056 | - | 352 | 1100 | 4 | 15 |

0499 **ROUND** ALUMINIUM Designer: Balutto Associati

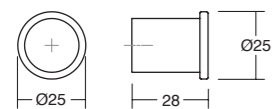

| L24 | L291 | L30 | ↓ | ☐ |
|----------------------|------------------------|------------------------|---|----|
| Stainless steel look | Brushed brass | Brushed black | | |
| <i>Inox look</i> | <i>Latón cepillado</i> | <i>Negro cepillado</i> | | |
| 0499025L24 | 0499025L291 | 0499025L30 | 1 | 25 |

0489 **BOL** ZAMAK / WOOD Designer: Balutto Associati

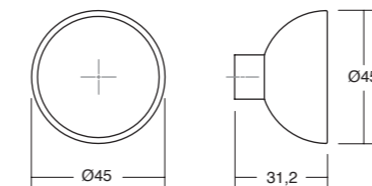

| NM222 (ZM2+W22) | NM223 (ZM2+W23) | NM2M1 (ZM2+WM1) | ↓ | ☐ |
|-----------------------------|--------------------------|--|---|----|
| Matt black + Sapelli | Matt black + Beech | Matt black + Matt white lacquered | | |
| <i>Negro mate + Sapelli</i> | <i>Negro mate + Haya</i> | <i>Negro mate + Lacado blanco mate</i> | | |
| 0489045NM222 | 0489045NM223 | 0489045NM2M1 | 1 | 25 |

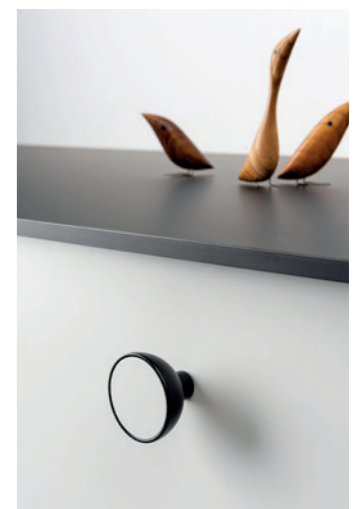

0511 **RAIL** ALUMINIUM Designer: Teruel & Paré

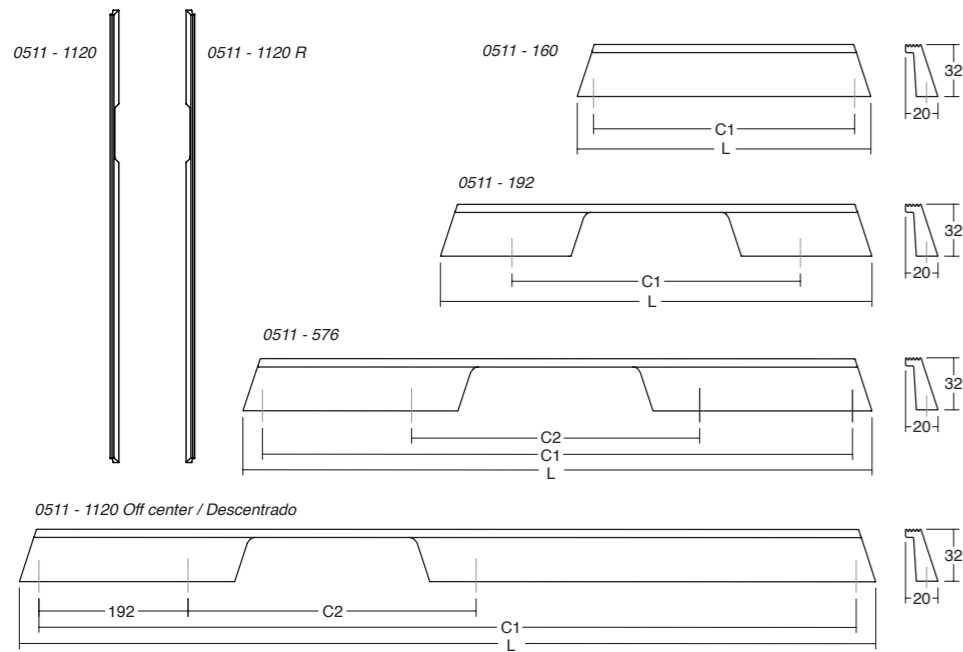

| L24 | L30 | L618 | C1 | C2 | L | ↓ | ☐ |
|-----------------------------------|----------------------------------|--|------|-----|------|---|----|
| Stainless steel look Inox look | Brushed black Negro cepillado | Brushed brass cava Latón cava cepillado | | | | | |
| 0511160L24 | 0511160L30 | 0511160L618 | 160 | - | 180 | 2 | 25 |
| 0511192L24 | 0511192L30 | 0511192L618 | 192 | - | 280 | 2 | 25 |
| 0511576L24 | 0511576L30 | 0511576L618 | 576 | 192 | 600 | 4 | 15 |
| 05111120L24* | 05111120L30* | 05111120L618* | 1120 | 192 | 1150 | 4 | 15 |
| 05111120L24R* | 05111120L30R* | 05111120L618R* | 1120 | 192 | 1150 | 4 | 15 |

* The two 1150mm are symmetrical and one is left and the other right / Los dos de 1150mm son simétricos y uno es izquierda y el otro derecha

0507 **OBLONG** LEATHER / ZAMAK Designer: Frank Person

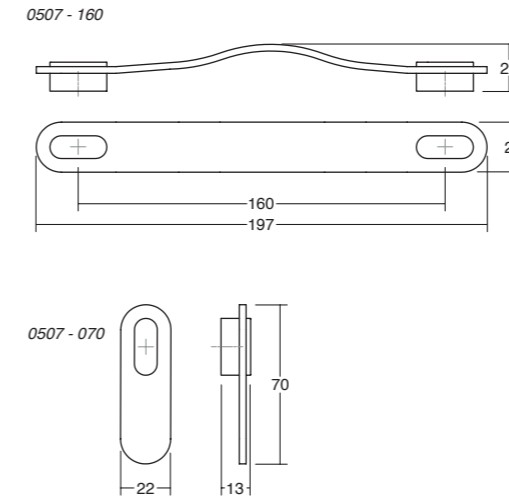

| | P26 Beige / Beige | P36 Brown / Marrón | P99 Black / Negro | ↓ | ☐ |
|-----------------------------------|----------------------|-----------------------|----------------------|---|----|
| Z01 Polished chrome/ Cromo brillo | 0507070P2601 | 0507070P3601 | 0507070P9901 | 1 | 25 |
| Z01 Polished chrome/ Cromo brillo | 0507160P2601 | 0507160P3601 | 0507160P9901 | 2 | 25 |
| Z28 Brushed gold / Oro cepillado | 0507070P2628 | 0507070P3628 | 0507070P9928 | 1 | 25 |
| Z28 Brushed gold / Oro cepillado | 0507160P2628 | 0507160P3628 | 0507160P9928 | 2 | 25 |
| Z31 Brushed grey / Gris cepillado | 0507070P2631 | 0507070P3631 | 0507070P9931 | 1 | 25 |
| Z31 Brushed grey / Gris cepillado | 0507160P2631 | 0507160P3631 | 0507160P9931 | 2 | 25 |
| ZM1 Matt white / Blanco mate | 0507070P26M1 | - | - | 1 | 25 |
| ZM1 Matt white / Blanco mate | 0507160P26M1 | - | - | 2 | 25 |
| ZM2 Matt black / Negro mate | 0507070P26M2 | 0507070P36M2 | 0507070P99M2 | 1 | 25 |
| ZM2 Matt black / Negro mate | 0507160P26M2 | 0507160P36M2 | 0507160P99M2 | 2 | 25 |

0056 **U** ZAMAK Designer: Viefe Studio

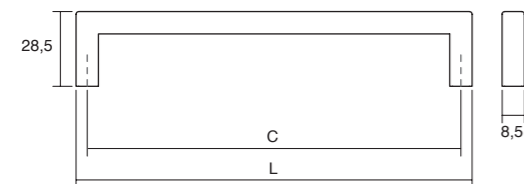

| Z01 | Z11 | Z23 | Z26 | Z27 | Z31 | ZM1 | ZM2 | C | L | ↓ | ☐ |
|---------------------------------|---------------------------|------------------------------------|-----------------------------------|----------------------------------|--------------------------------|---------------------------|--------------------------|-----|-------|---|----|
| Polished chrome Cromo brillo | Matt chrome Cromo mate | Brushed nickel Níquel cepillado | Brushed copper Cobre cepillado | Brushed brass Latón cepillado | Brushed grey Gris cepillado | Matt white Blanco mate | Matt black Negro mate | | | | |
| 0056128Z01 | 0056128Z11 | 0056128Z23 | 0056128Z26 | 0056128Z27 | 0056128Z31 | 0056128ZM1 | 0056128ZM2 | 128 | 136,5 | 2 | 25 |
| 0056160Z01 | 0056160Z11 | 0056160Z23 | 0056160Z26 | 0056160Z27 | 0056160Z31 | 0056160ZM1 | 0056160ZM2 | 160 | 168,5 | 2 | 25 |
| 0056192Z01 | 0056192Z11 | 0056192Z23 | 0056192Z26 | 0056192Z27 | 0056192Z31 | 0056192ZM1 | 0056192ZM2 | 192 | 200,5 | 2 | 25 |
| 0056320Z01 | 0056320Z11 | 0056320Z23 | 0056320Z26 | 0056320Z27 | 0056320Z31 | 0056320ZM1 | 0056320ZM2 | 320 | 328,5 | 2 | 25 |
| 0056492Z01 | 0056492Z11 | 0056492Z23 | 0056492Z26 | 0056492Z27 | 0056492Z31 | 0056492ZM1 | 0056492ZM2 | 492 | 500,5 | 2 | 25 |

0241 **ROMA** ZAMAK Designer: 2J Design

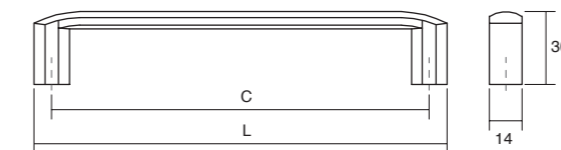

| Z01 | Z23 | Z28 | ZM2 | C | L | ↓ | ☐ |
|---------------------------------|------------------------------------|-------------------------------|--------------------------|-----|-----|---|----|
| Polished chrome Cromo brillo | Brushed nickel Níquel cepillado | Brushed gold Oro cepillado | Matt black Negro mate | | | | |
| 0241160Z01 | 0241160Z23 | 0241160Z28 | 0241160ZM2 | 160 | 175 | 2 | 25 |
| 0241192Z01 | 0241192Z23 | 0241192Z28 | 0241192ZM2 | 192 | 207 | 2 | 25 |
| 0241320Z01 | 0241320Z23 | 0241320Z28 | 0241320ZM2 | 320 | 335 | 2 | 25 |

0494 **LAND** ZAMAK Designer: Héctor Diego

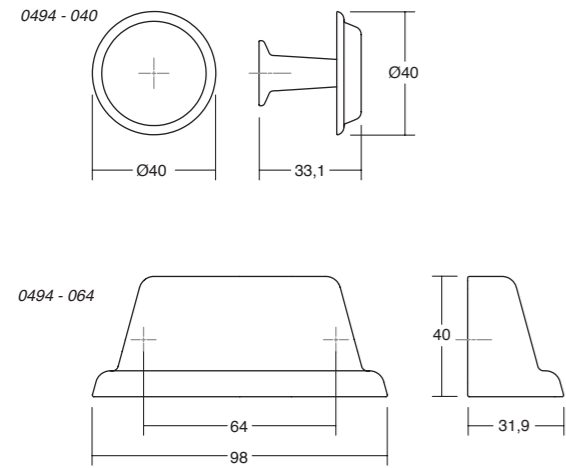

| Z28 | Z610 | Z614 | ZM2 | ↓ | 📦 |
|-------------------------------|------------------|--------------------------------|--------------------------|---|----|
| Brushed gold Oro cepillado | Pewter Peltre | Antique brass Latón antiguo | Matt black Negro mate | | |
| 0494040Z28 | 0494040Z610 | 0494040Z614 | 0494040ZM2 | 1 | 25 |
| 0494064Z28 | 0494064Z610 | 0494064Z614 | 0494064ZM2 | 2 | 25 |



0506 **FIRM** ZAMAK Designer: Frank Person

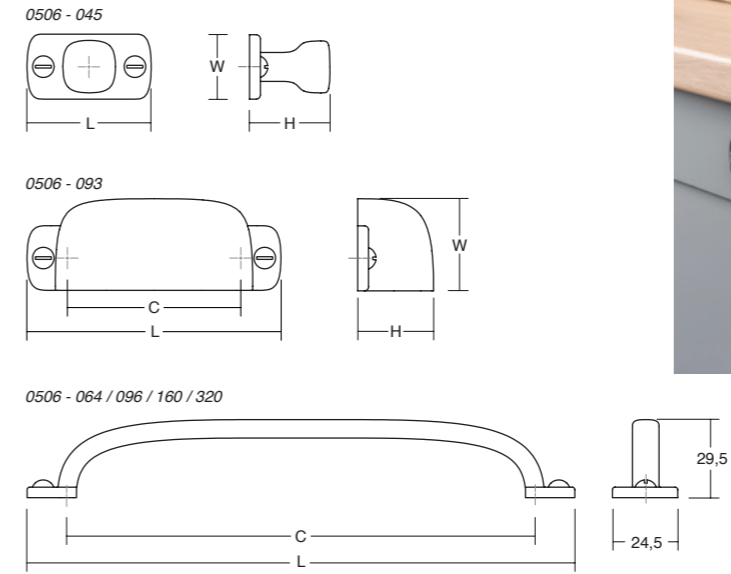

| ZM22 | C | L | W | H | ↓ | 📦 |
|-------------------------------------|-----|-------|------|------|---|----|
| Textured black Negro texturizado | | | | | | |
| 0506045ZM22 | - | 45,8 | 24 | 29,9 | 1 | 25 |
| 0506064ZM22 | 64 | 93,8 | 24,5 | 29,5 | 2 | 25 |
| 0506093ZM22 | 64 | 93,8 | 34 | 28 | 2 | 25 |
| 0506096ZM22 | 96 | 125,8 | 24,5 | 29,5 | 2 | 25 |
| 0506160ZM22 | 160 | 189,8 | 24,5 | 29,6 | 2 | 25 |
| 0506320ZM22 | 320 | 349,8 | 24,5 | 29,6 | 2 | 25 |



0446 **ESTE** ZAMAK Designer: Balutto Associati

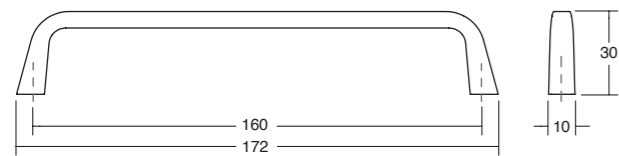

| Z01 | Z11 | Z23 | Z26 | Z28 | Z617 | ZM2 | ↓ | 📦 |
|---------------------------------|---------------------------|------------------------------------|-----------------------------------|-------------------------------|-------------------------------|--------------------------|---|----|
| Polished chrome Cromo brillo | Matt chrome Cromo mate | Brushed nickel Níquel cepillado | Brushed copper Cobre cepillado | Brushed gold Oro cepillado | Graphite grey Gris grafito | Matt black Negro mate | | |
| 0446160Z01 | 0446160Z11 | 0446160Z23 | 0446160Z26 | 0446160Z28 | 0446160Z617 | 0446160ZM2 | 2 | 25 |



0459 **LINES** ZAMAK Designer: Teruel & Paré

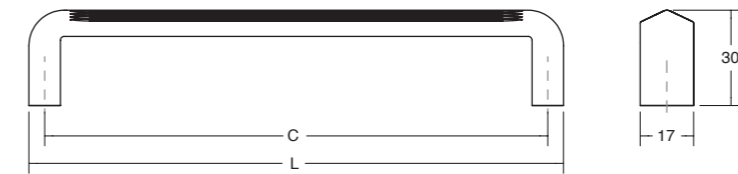

| Z23 | Z28 | Z32 | ZM2 | C | L | ↓ | 📦 |
|------------------------------------|-------------------------------|--|--------------------------|-----|-----|---|----|
| Brushed Níquel Níquel cepillado | Brushed gold Oro cepillado | Brushed mole grey Gris topo cepillado | Matt black Negro mate | | | | |
| 0459160Z23 | 0459160Z28 | 0459160Z32 | 0459160ZM2 | 160 | 170 | 2 | 25 |
| 0459320Z23 | 0459320Z28 | 0459320Z32 | 0459320ZM2 | 320 | 330 | 2 | 25 |

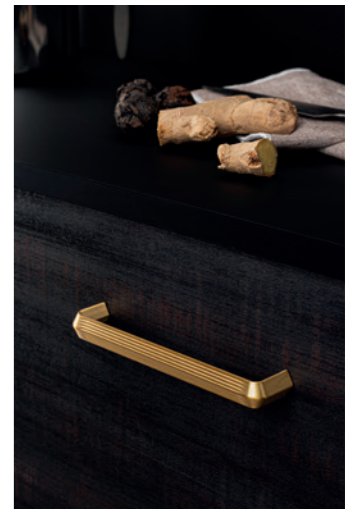

0516 **PENDANT** ZAMAK Designer: Frank Person

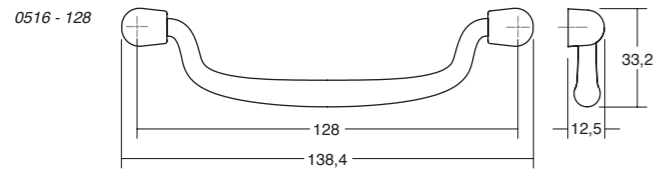
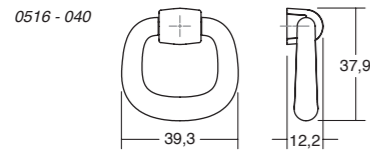

| Z610 | Z614 | ZM2 | ↓ | ☐ |
|-------------|---------------|------------|---|----|
| Pewter | Antique brass | Matt black | | |
| Peltre | Latón antiguo | Negro mate | | |
| 0516040Z610 | 0516040Z614 | 0516040ZM2 | 1 | 25 |
| 0516128Z610 | 0516128Z614 | 0516128ZM2 | 2 | 25 |



0486 **GRAF BIG** ALUMINIUM Designer: Viefe Studio

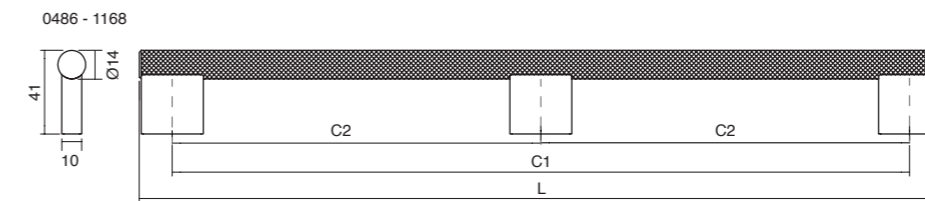
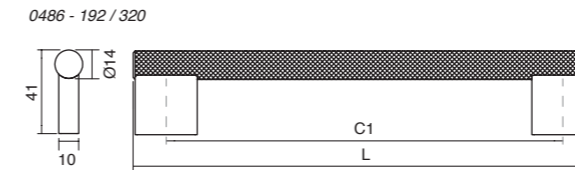
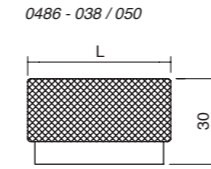

| L24 | L291 | L30 | C1 | C2 | L | ↓ | ☐ |
|----------------------|-----------------|-----------------|------|-----|------|---|----|
| Stainless steel look | Brushed brass | Brushed black | | | | | |
| Inox look | Latón cepillado | Negro cepillado | | | | | |
| 0486038L24 | 0486038L291 | 0486038L30 | - | - | Ø38 | 1 | 25 |
| 0486050L24 | 0486050L291 | 0486050L30 | - | - | Ø50 | 1 | 25 |
| 0486192L24 | 0486192L291 | 0486192L30 | 192 | - | 224 | 2 | 25 |
| 0486320L24 | 0486320L291 | 0486320L30 | 320 | - | 352 | 2 | 25 |
| 04861168L24 | 04861168L291 | 04861168L30 | 1168 | 584 | 1200 | 3 | 10 |



0094 **HIDE** ZAMAK Designer: Viefe Studio

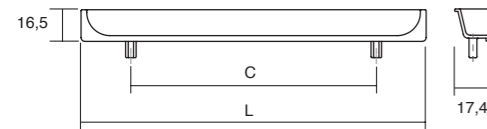

| Z01 | Z23 | Z28 | ZP1 | ZM1 | ZM2 | C | L | ↓ | ☐ |
|-----------------|------------------|---------------|-------------|-------------|------------|-----|-----|---|----|
| Polished chrome | Brushed nickel | Brushed gold | Chrome look | Matt white | Matt black | | | | |
| Cromo brillo | Níquel cepillado | Oro cepillado | Cromo look | Blanco mate | Negro mate | | | | |
| 0094090Z01 | 0094090Z23 | 0094090Z28 | - | 0094090ZM1 | 0094090ZM2 | 64 | 90 | 2 | 25 |
| 0094180Z01 | 0094180Z23 | 0094180Z28 | - | 0094180ZM1 | 0094180ZM2 | 128 | 180 | 2 | 25 |
| - | - | - | 0094200ZP1 | - | - | 128 | 200 | 2 | 25 |

0430 **GRAF MINI** ALUMINIUM Designer: Viefe Studio

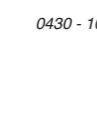
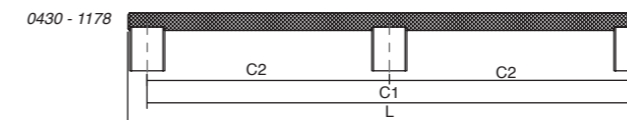
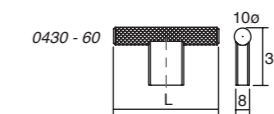
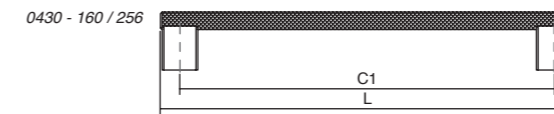

| L24 | L291 | L30 | C1 | C2 | L | ↓ | ☐ |
|----------------------|-----------------|-----------------|------|-----|------|---|----|
| Stainless steel look | Brushed brass | Brushed black | | | | | |
| Inox look | Latón cepillado | Negro cepillado | | | | | |
| 0430010L24 | 0430010L291 | 0430010L30 | - | - | 10 | 1 | 25 |
| 0430060L24 | 0430060L291 | 0430060L30 | - | - | 60 | 1 | 25 |
| 0430160L24 | 0430160L291 | 0430160L30 | 160 | - | 182 | 2 | 25 |
| 0430256L24 | 0430256L291 | 0430256L30 | 256 | - | 278 | 2 | 25 |
| 04301178L24 | 04301178L291 | 04301178L30 | 1178 | 589 | 1200 | 3 | 10 |

Includes non-twisting tip
Incluye punta anti-giro



0109 **GRAF** ALUMINIUM Designer: Viefe Studio

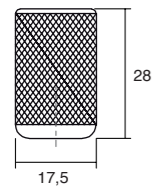

| | | | | | | |
|--|--|---|---|---|---|---|
| L01 Polished chrome <i>Cromo brillo</i> 0109017L01 | L04 Anodized matt <i>Anodizado mate</i> 0109017L04 | L24 Stain. steel look <i>Inox look</i> 0109017L24 | L27 Brushed brass <i>Latón cepillado</i> 0109017L27 | L291 Brushed brass <i>Latón cepillado</i> 0109017L291 | LM2 Matt black <i>Negro mate</i> 0109017LM2 | ↓ |
| 1 25 | | | | | | |

0447 **BELLA** ZAMAK Designer: Balutto Associati

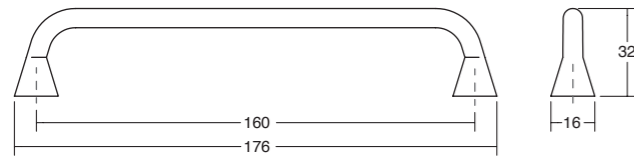

| | | | | |
|--|--|--|---|---|
| Z26 Brushed copper <i>Cobre cepillado</i> 0447160Z26 | Z28 Brushed gold <i>Oro cepillado</i> 0447160Z28 | Z617 Graphite grey <i>Gris grafito</i> 0447160Z617 | ZM2 Matt black <i>Negro mate</i> 0447160ZM2 | ↓ |
| 2 25 | | | | |

0451 **FELTRE** ZAMAK Designer: Balutto Associati

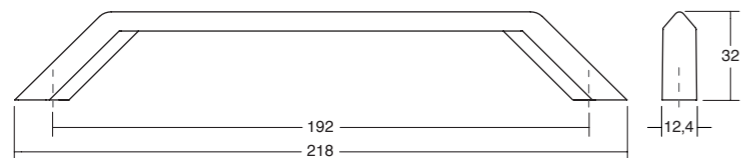

| | | | |
|---|--|---|---|
| Z23 Brushed nickel <i>Níquel cepillado</i> 0451192Z23 | Z617 Graphite grey <i>Gris grafito</i> 0451192Z617 | ZM2 Matt black <i>Negro mate</i> 0451192ZM2 | ↓ |
| 2 25 | | | |

0449 **HEXXA** ALUMINIUM/ZAMAK Designer: Alexis Vivet

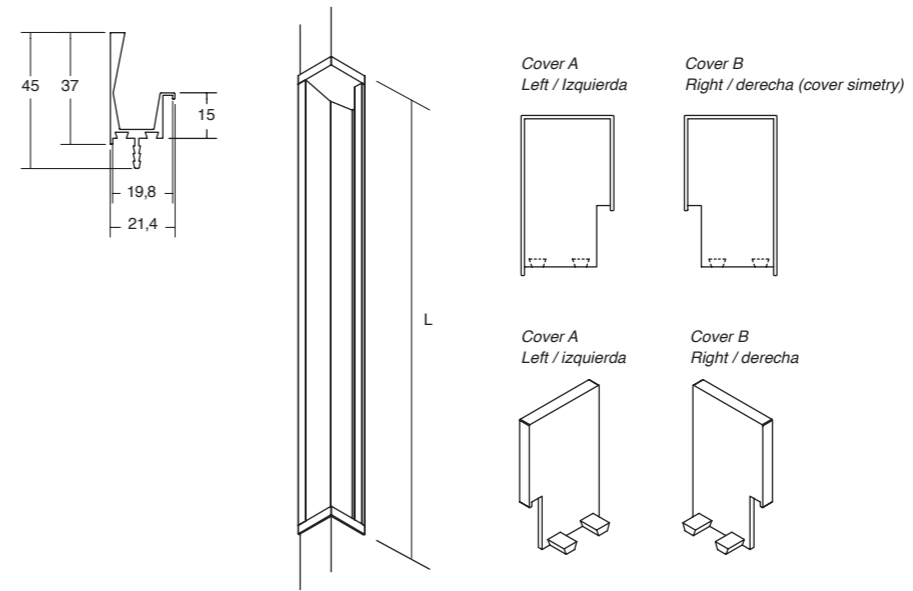

| | | | | | |
|--|---|--|---|------|---------------|
| LM1 Matt white <i>Blanco mate</i> 0449200LM1 | LM2 Matt black <i>Negro mate</i> 0449200LM2 | LM23 Metallic grey <i>Gris metal</i> 0449200LM23 | LM41 Metallic brown <i>Marrón metal</i> 0449200LM41 | L | |
| 0449350LM1 | 0449350LM2 | 0449350LM23 | 0449350LM41 | 200 | 25 ALUMINIUM |
| 04491100LM1 | 04491100LM2 | 04491100LM23 | 04491100LM41 | 350 | 25 ALUMINIUM |
| 04493000LM1 | 04493000LM2 | 04493000LM23 | 04493000LM41 | 1100 | 15 ALUMINIUM |
| 0449035ZM1A | 0449035ZM2A | 0449035ZM23A | 0449035ZM41A | 3000 | 10* ALUMINIUM |
| 0449035ZM1B | 0449035ZM2B | 0449035ZM23B | 0449035ZM41B | - | 25 ZAMAK |
| | | | | - | 25 ZAMAK |

* Three metre profiles are delivered according to the units of the original packaging and cannot be sold separately.
Las barras de tres metros se sirven según las cantidades del embalaje original y no se pueden servir por separado.



0119 **WAVE** ZAMAK Designer: Viefe Studio

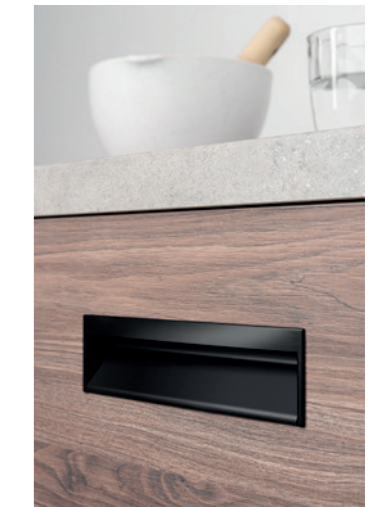
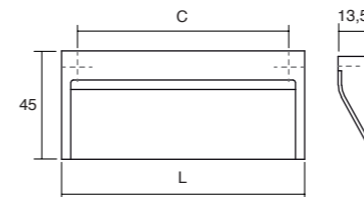

| | | | | | |
|--|---|---|-----|-----|------|
| Z01 Polished chrome <i>Cromo brillo</i> 0119032Z01 | Z23 Brushed nickel <i>Níquel cepillado</i> 0119032Z23 | ZM2 Matt black <i>Negro mate</i> 0119032ZM2 | C | L | ↓ |
| 0119160Z01 | 0119160Z23 | 0119160ZM2 | 32 | 45 | 2 25 |
| | | | 160 | 173 | 2 25 |

0105 NEST

ZAMAK

Designer: Viefe Studio

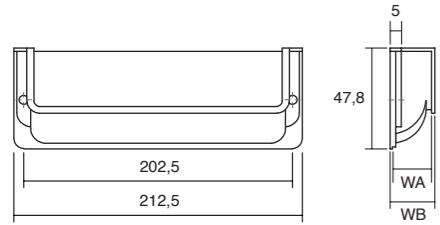

| Z01 | Z01M1 | Z23 | Z23M1 | ZM2 | WA | WB | ↓ | ☐ | Door |
|--|--|---|--|---------------------------------|------|------|---|----|------|
| Polished chrome <i>Cromo brillo</i> | Polished chrome+White <i>Cromo brillo+ Blanco</i> | Brushed nickel <i>Níquel cepillado</i> | Brushed nickel+White <i>Níquel cepillado+Blanco</i> | Matt black <i>Negro mate</i> | | | | | |
| 0105186Z01ST | 0105186Z01M1 | 0105186Z23ST | 0105186Z23M1 | 0105186ZM2ST | 18,6 | 21,3 | 2 | 25 | 19 |
| - | - | 0105206Z23ST | - | - | 20,6 | 23,3 | 2 | 25 | 20,5 |

0073 TAP

ZAMAK

Designer: Viefe Studio

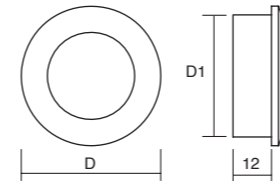

| ZP1 | ZM2 | D | D1 | ☐ |
|----------------------------------|---------------------------------|----|------|----|
| Chrome look <i>Cromo look</i> | Matt black <i>Negro mate</i> | | | |
| 0073040ZP1 | 0073040ZM2 | 40 | 35,5 | 25 |
| 0073060ZP1 | 0073060ZM2 | 60 | 55,3 | 25 |

0235 CLOS

ZAMAK

Designer: Viefe Studio

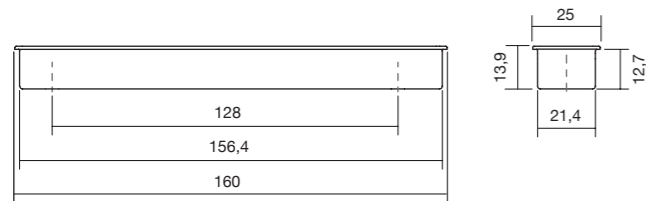

| ZM1 | ZM2 | Z01 | Z23 | ↓ | ☐ |
|----------------------------------|---------------------------------|--|---|---|----|
| Matt white <i>Blanco mate</i> | Matt black <i>Negro mate</i> | Polished chrome <i>Cromo brillo</i> | Brushed nickel <i>Níquel cepillado</i> | | |
| 0235128ZM1 | 0235128ZM2 | 0235128Z01 | 0235128Z23 | 2 | 25 |

0301 SENSE MINI

ALUMINIUM

Designer: Viefe Studio

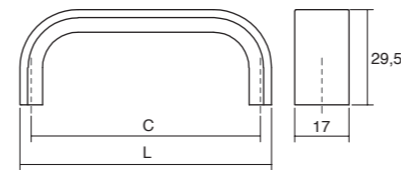

| L01 | L09 | L24 | L29 | C | L | ↓ | ☐ |
|--|---------------------------------|--|---|-----|-----|---|----|
| Polished chrome <i>Cromo brillo</i> | Matt black <i>Negro mate</i> | Stainless steel look <i>inox look</i> | Brushed dark brass <i>Latón oscuro cepillado</i> | | | | |
| 0301096L01 | 0301096L09 | 0301096L24 | 0301096L29 | 96 | 103 | 2 | 25 |
| 0301160L01 | 0301160L09 | 0301160L24 | 0301160L29 | 160 | 167 | 2 | 25 |
| 0301256L01 | 0301256L09 | 0301256L24 | 0301256L29 | 256 | 263 | 2 | 25 |

0366 CUBIC

ZAMAK

Designer: Viefe Studio

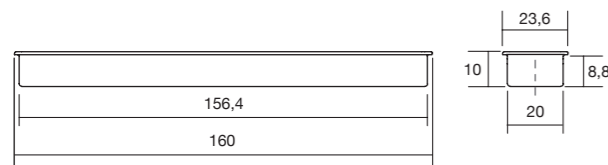

| ZM1 | ZM2 | ☐ |
|----------------------------------|---------------------------------|----|
| Matt white <i>Blanco mate</i> | Matt black <i>Negro mate</i> | |
| 0366160ZM1 | 0366160ZM2 | 25 |

0195 SENSE

ALUMINIUM

Designer: Viefe Studio

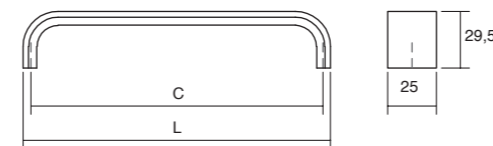

| L01 | L24 | L30 | C | L | ↓ | ☐ |
|--|--|---|-----|-----|---|----|
| Polished chrome <i>Cromo brillo</i> | Stainless steel look <i>Inox look</i> | Brushed black <i>Negro cepillado</i> | | | | |
| 0195128L01 | 0195128L24 | 0195128L30 | 128 | 135 | 2 | 25 |
| 0195192L01 | 0195192L24 | 0195192L30 | 192 | 199 | 2 | 25 |
| 0195320L01 | 0195320L24 | 0195320L30 | 320 | 327 | 2 | 25 |
| 0195480L01 | 0195480L24 | 0195480L30 | 480 | 487 | 2 | 25 |

0162 **KADO**

ZAMAK

Designer: Viefe Studio

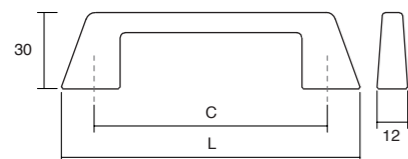

| Z01 | Z23 | C | L | ↓ | ☐ |
|--|---|-----|-----|---|----|
| Polished chrome <i>Cromo brillo</i> | Brushed nickel <i>Níquel cepillado</i> | | | | |
| 0162160Z01 | 0162160Z23 | 160 | 186 | 2 | 25 |
| 0162320Z01 | 0162320Z23 | 320 | 346 | 2 | 25 |

0077 **ANGLE**

ALUMINIUM

Designer: Viefe Studio

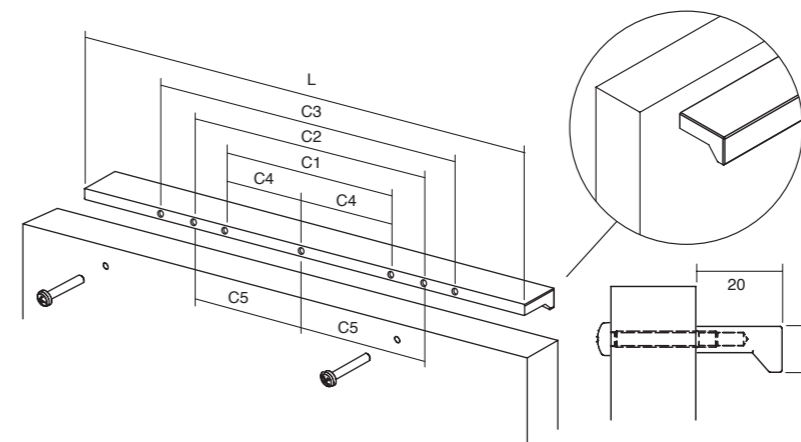

| L01 | L04 | L24 | L29 | LM1 | LM2 | LM23 | LM41 | C1 | C2 | C3 | C4 | C5 | L | ↓ | ☐ |
|---------------------------------------|--|--------------------------------------|---|----------------------------------|---------------------------------|------------------------------------|---------------------------------------|-----|------|-----|-----|-----|------|---|----|
| Polish. chrome <i>Cromo brillo</i> | Anodized matt <i>Anodizado mate</i> | Stai. steel look <i>Inox look</i> | Brus. dark brass <i>Ltn osc. cepillado</i> | Matt White <i>Blanco mate</i> | Matt black <i>Negro mate</i> | Metallic grey <i>Gris metal</i> | Metallic brown <i>Marrón metal</i> | | | | | | | | |
| - | 0077032L04 | - | - | - | - | - | - | 32 | - | - | - | - | 45 | 2 | 25 |
| - | 0077064L04 | - | - | - | - | - | - | 64 | - | - | - | - | 90 | 2 | 25 |
| 0077064L01 | - | 0077064L24 | 0077064L29 | 0077064LM1 | 0077064LM2 | 0077064LM23 | 0077064LM41 | 64 | - | - | - | - | 100 | 2 | 25 |
| - | - | - | - | 0077128LM1 | 0077128LM2 | 0077128LM23 | 0077128LM41 | 128 | 160 | - | - | - | 200 | 4 | 25 |
| - | 0077096L04 | - | - | - | - | - | - | 96 | - | - | - | - | 120 | 2 | 25 |
| - | 0077128L04 | - | - | - | - | - | - | 128 | - | - | - | - | 150 | 2 | 25 |
| 0077128L01 | - | 0077128L24 | 0077128L29 | - | - | - | - | 96 | 128 | 160 | - | - | 200 | 6 | 25 |
| - | 0077160L04 | - | - | - | - | - | - | 160 | - | - | - | - | 190 | 2 | 25 |
| - | 0077192L04 | - | - | - | - | - | - | 192 | - | - | - | - | 250 | 2 | 25 |
| 0077192L01 | - | 0077192L24 | 0077192L29 | 0077192LM1 | 0077192LM2 | 0077192LM23 | 0077192LM41 | 192 | - | - | - | - | 300 | 2 | 25 |
| - | - | - | - | 0077256LM1 | 0077256LM2 | 0077256LM23 | 0077256LM41 | 256 | - | - | - | - | 400 | 2 | 25 |
| - | 0077256L04 | - | - | - | - | - | - | 256 | - | - | - | - | 300 | 2 | 25 |
| 0077256L01 | - | 0077256L24 | 0077256L29 | - | - | - | - | 256 | 320 | - | - | - | 400 | 4 | 25 |
| - | - | - | - | 0077416LM1 | 0077416LM2 | 0077416LM23 | 0077416LM41 | 416 | - | - | - | - | 500 | 2 | 25 |
| 0077416L01 | - | 0077416L24 | 0077416L29 | - | - | - | - | 320 | 416 | - | - | - | 500 | 4 | 25 |
| - | - | - | - | 0077480LM1 | 0077480LM2 | 0077480LM23 | 0077480LM41 | 480 | - | - | - | - | 600 | 2 | 25 |
| 0077512L01 | - | 0077512L24 | 0077512L29 | - | - | - | - | 480 | 512 | - | - | 256 | 600 | 5 | 25 |
| 0077640L01 | - | 0077640L24 | 0077640L29 | 0077640LM1 | 0077640LM2 | 0077640LM23 | 0077640LM41 | 640 | - | - | 320 | - | 900 | 3 | 25 |
| - | - | - | - | 00771440LM1 | 00771440LM2 | 00771440LM23 | 00771440LM41 | 480 | 1440 | - | - | - | 1480 | 4 | 10 |

0373 **NICK**

ZAMAK

Designer: Alexis Vivet

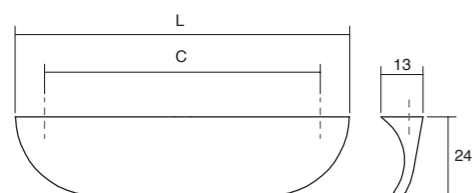

| Z01 | Z23 | Z26 | Z27 | C | L | ↓ | ☐ |
|--|---|--|---|-----|-----|---|----|
| Polished chrome <i>Cromo brillo</i> | Brushed nickel <i>Níquel cepillado</i> | Brushed copper <i>Cobre cepillado</i> | Brushed brass <i>Latón cepillado</i> | | | | |
| 0373032Z01 | 0373032Z23 | 0373032Z26 | 0373032Z27 | 32 | 50 | 2 | 25 |
| 0373160Z01 | 0373160Z23 | 0373160Z26 | 0373160Z27 | 160 | 178 | 2 | 25 |

0206 **ARCH**

ZAMAK

Designer: 2J Design

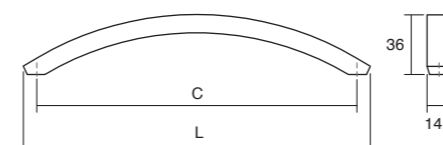

| Z01 | Z23 | C | L | ↓ | ☐ |
|--|---|-----|-------|---|----|
| Polished chrome <i>Cromo brillo</i> | Brushed nickel <i>Níquel cepillado</i> | | | | |
| 0206192Z01 | 0206192Z23 | 192 | 208,5 | 2 | 25 |
| 0206320Z01 | 0206320Z23 | 320 | 338,5 | 2 | 25 |

0452 **BRAVE** ALUMINIUM Designer: Viefe Studio

| LM1 | LM2 | LM23 | LM41 | C1 | C2 | L | ↓ | ⊞ |
|---------------------------|--------------------------|-----------------------------|--------------------------------|-----|------|------|---|----|
| Matt white Blanco mate | Matt black Negro mate | Metallic grey Gris metal | Metallic brown Marrón metal | | | | | |
| 0452128FM1 | 0452128FM2 | 0452128FM23 | 0452128FM41 | 128 | - | 160 | 2 | 25 |
| 0452192FM1 | 0452192FM2 | 0452192FM23 | 0452192FM41 | 192 | - | 240 | 2 | 25 |
| 0452320FM1 | 0452320FM2 | 0452320FM23 | 0452320FM41 | 320 | - | 400 | 2 | 25 |
| 0452480FM1 | 0452480FM2 | 0452480FM23 | 0452480FM41 | 192 | 480 | 600 | 4 | 25 |
| 0452992FM1 | 0452992FM2 | 0452992FM23 | 0452992FM41 | 192 | 992 | 1040 | 4 | 15 |
| 04521120FM1 | 04521120FM2 | 04521120FM23 | 04521120FM41 | 192 | 1120 | 1150 | 4 | 15 |

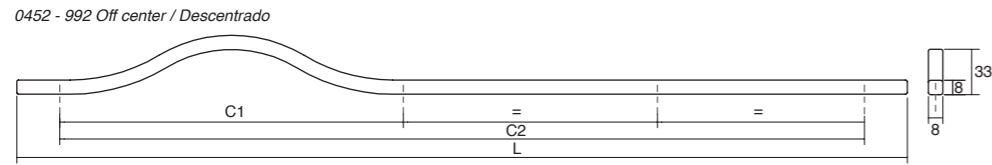
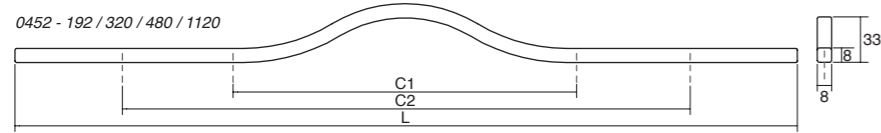
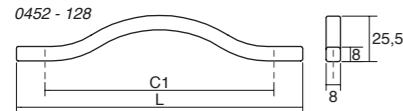

0444 **PEAK** ALUMINIUM Designer: Viefe Studio

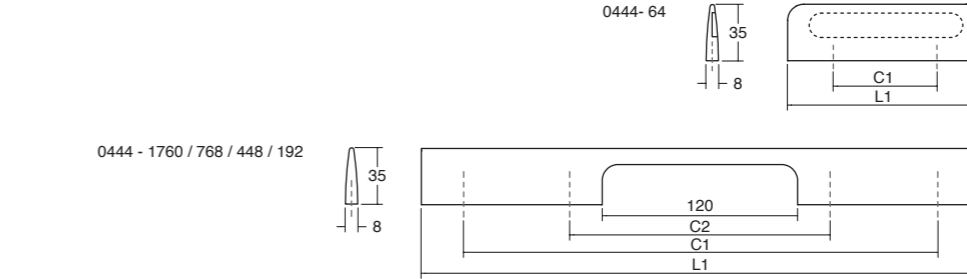

0444 - 1760 / 768 / 448 / 192

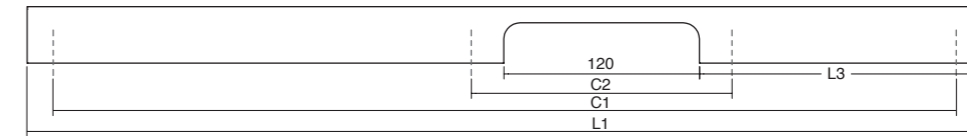

| L24 | L30 | LM1 | LM23 | LM41 | C1 | C2 | L1 | L3 | ↓ | ⊞ |
|--------------------------------|----------------------------------|---------------------------|-----------------------------|--------------------------------|------|-----|------|-----|---|----|
| Stain. steel look Inox look | Brushed black Negro cepillado | Matt white Blanco mate | Metallic grey Gris metal | Metallic brown Marrón metal | | | | | | |
| 0444064L24 | 0444064L30 | 0444064LM1 | 0444064LM23 | 0444064LM41 | 64 | - | 120 | - | 2 | 25 |
| 0444192L24 | 0444192L30 | 0444192LM1 | 0444192LM23 | 0444192LM41 | 192 | 160 | 250 | - | 4 | 25 |
| 0444448L24 | 0444448L30 | 0444448LM1 | 0444448LM23 | 0444448LM41 | 448 | 160 | 500 | - | 4 | 25 |
| 0444768L24 | 0444768L30 | 0444768LM1 | 0444768LM23 | 0444768LM41 | 768 | 160 | 800 | - | 4 | 15 |
| 04441120L24 | 04441120L30 | 04441120LM1 | 04441120LM23 | 04441120LM41 | 1120 | 160 | 1150 | 190 | 4 | 15 |
| 04441760L24 | 04441760L30 | 04441760LM1 | 04441760LM23 | 04441760LM41 | 1760 | 160 | 1800 | - | 4 | 10 |



0322 **CUTT** ALUMINIUM Designer: Alexis Vivet

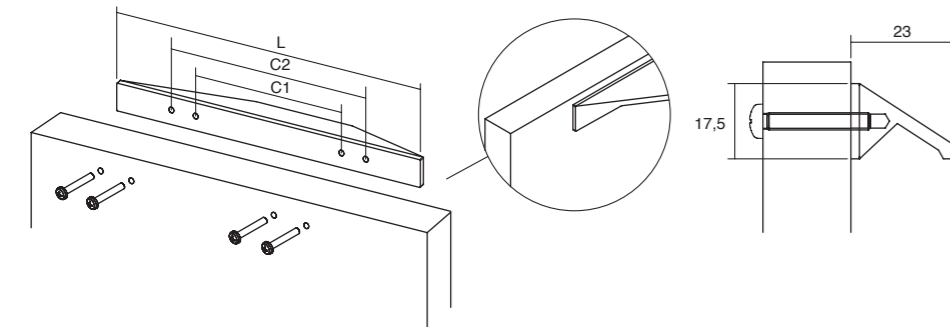

| L01 | L09 | L24 | C1 | C2 | L | ↓ | ⊞ |
|---------------------------------|--------------------------|-----------------------------------|-----|------|------|---|----|
| Polished chrome Cromo brillo | Matt black Negro mate | Stainless steel look Inox look | | | | | |
| 0322200L01 | 0322200L09 | 0322200L24 | 96 | 128 | 200 | 4 | 25 |
| 0322400L01 | 0322400L09 | 0322400L24 | 192 | 320 | 400 | 4 | 25 |
| 0322600L01 | 0322600L09 | 0322600L24 | 320 | 480 | 600 | 4 | 25 |
| - | 03221000L09 | 03221000L24 | 320 | 896 | 1000 | 4 | 15 |
| - | 03221500L09 | 03221500L24 | 480 | 1376 | 1500 | 4 | 10 |



0375 **VANN** ALUMINIUM Designer: Alexis Vivet

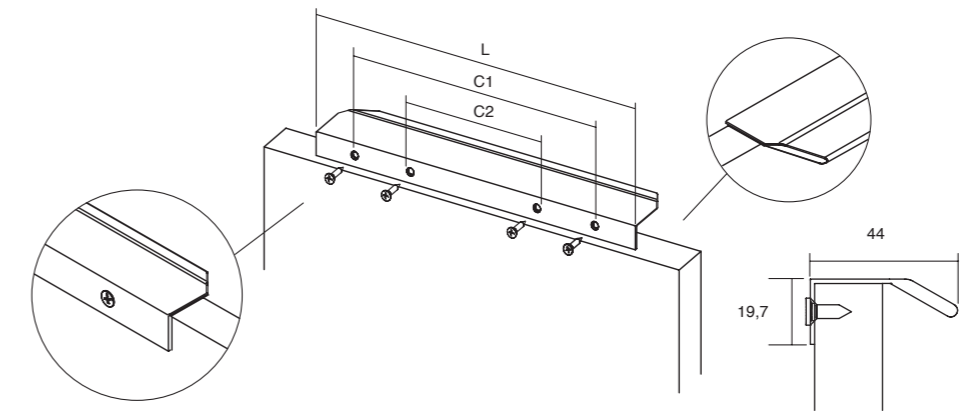

| L02 | L04 | L09 | L24 | L29 | C1 | C2 | L | ↓ | ⊞ |
|-------------------------------------|---------------------------------|--------------------------|-------------------------------|--|------|-----|------|---|----|
| Anodized bright Anodizado brillo | Anodized matt Anodizado mate | Matt black Negro mate | Stain steel look Inox look | Brushed dark brass Latón oscuro cepill. | | | | | |
| 0375064L02 | 0375064L04 | 0375064L09 | 0375064L24 | 0375064L29 | 64 | - | 100 | 2 | 25 |
| 0375128L02 | 0375128L04 | 0375128L09 | 0375128L24 | 0375128L29 | 128 | - | 200 | 2 | 25 |
| 0375256L02 | 0375256L04 | 0375256L09 | 0375256L24 | 0375256L29 | 256 | - | 350 | 2 | 25 |
| - | 03751120L04 | 03751120L09 | 03751120L24 | 03751120L29 | 1120 | 384 | 1200 | 4 | 15 |



0372 **ONA** ALUMINIUM Designer: Teruel Paré

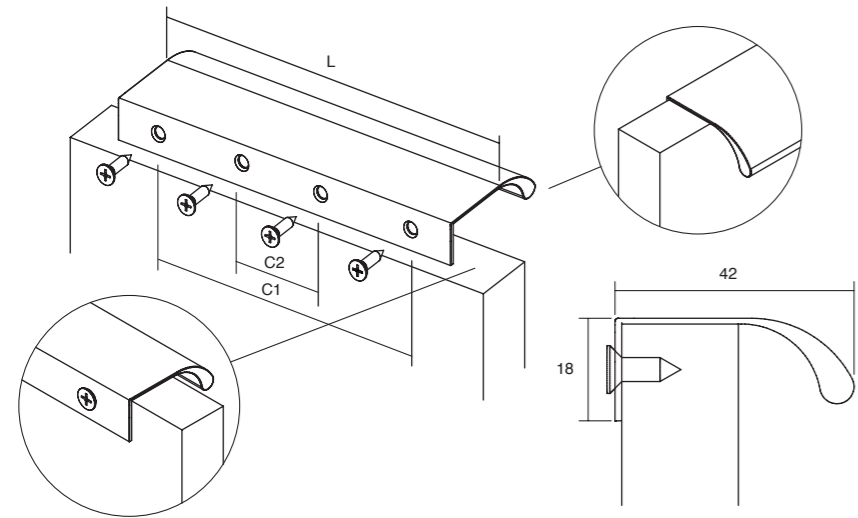

| L24 | L29 | L30 | L31 | LM1 | LM23 | LM41 | C1 | C2 | L | ↓ | ☐ |
|-----------------------------------|--|----------------------------------|--------------------------------|---------------------------|-----------------------------|--------------------------------|------|-----|------|---|----|
| Stainless steel look Inox look | Brushed dark brass Latón cepillado oscuro | Brushed black Negro cepillado | Brushed grey Gris cepillado | Matt white Blanco mate | Metallic grey Gris metal | Metallic brown Marrón metal | | | | | |
| 0372032L24 | 0372032L29 | 0372032L30 | 0372032L31 | 0372032LM1 | 0372032LM23 | 0372032LM41 | 32 | - | 50 | 2 | 25 |
| 0372128L24 | 0372128L29 | 0372128L30 | 0372128L31 | 0372128LM1 | 0372128LM23 | 0372128LM41 | 128 | - | 200 | 2 | 25 |
| 0372256L24 | 0372256L29 | 0372256L30 | 0372256L31 | 0372256LM1 | 0372256LM23 | 0372256LM41 | 256 | - | 350 | 2 | 25 |
| 0372544L24 | 0372544L29 | 0372544L30 | 0372544L31 | 0372544LM1 | 0372544LM23 | 0372544LM41 | 544 | - | 600 | 3 | 25 |
| 03721056L24 | 03721056L29 | 03721056L30 | 03721056L31 | 03721056LM1 | 03721056LM23 | 03721056LM41 | 1056 | 416 | 1100 | 4 | 15 |
| 03721440L24 | 03721440L29 | 03721440L30 | 03721440L31 | 03721440LM1 | 03721440LM23 | 03721440LM41 | 1440 | 480 | 1500 | 4 | 10 |

0053 **DINO** ZAMAK Designer: Viefe Studio

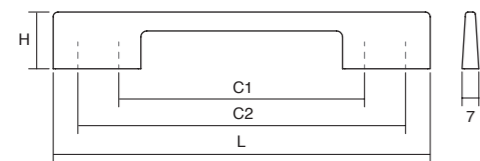

| Z01 | Z23 | ZM1 | ZM2 | ZP4 | C1 | C2 | L | H | ↓ | ☐ |
|---------------------------------|------------------------------------|---------------------------|--------------------------|---------------------------------|-----|-----|-----|----|---|----|
| Polished chrome Cromo brillo | Brushed nickel Níquel cepillado | Matt white Blanco mate | Matt black Negro mate | Aluminium look Aluminio look | | | | | | |
| 0053096Z01 | 0053096Z23 | 0053096ZM1 | 0053096ZM2 | 0053096ZP4 | 96 | 128 | 156 | 24 | 4 | 25 |
| 0053192Z01 | 0053192Z23 | 0053192ZM1 | 0053192ZM2 | 0053192ZP4 | 160 | 192 | 221 | 28 | 4 | 25 |
| 0053320Z01 | 0053320Z23 | 0053320ZM1 | 0053320ZM2 | 0053320ZP4 | 288 | 320 | 349 | 28 | 4 | 25 |

0117 **CURVE** ALUMINIUM Designer: Viefe Studio

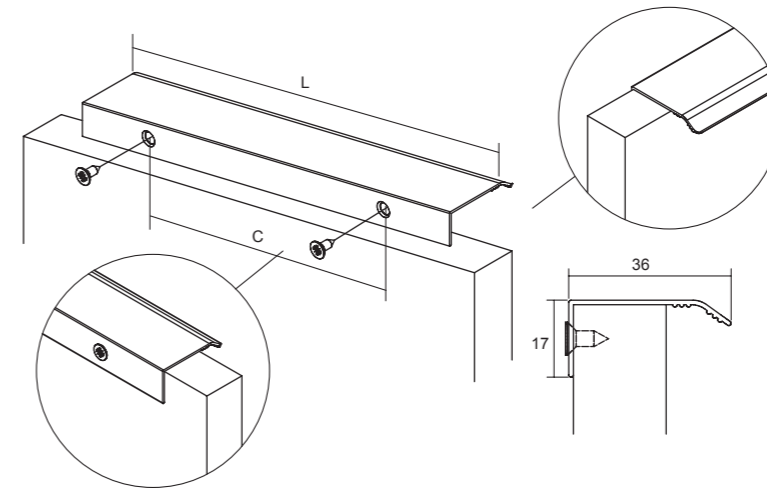

| L04 | L24 | L31 | LM1 | LM2 | C | L | ↓ | ☐ |
|---------------------------------|-----------------------------------|--------------------------------|---------------------------|--------------------------|-----|-----|---|----|
| Anodized matt Anodizado mate | Stainless steel look Inox look | Brushed grey Gris cepillado | Matt white Blanco mate | Matt black Negro mate | | | | |
| 0117032L04 | 0117032L24 | 0117032L31 | 0117032LM1 | 0117032LM2 | 32 | 45 | 2 | 25 |
| - | 0117064L24 | - | - | - | 64 | 100 | 2 | 25 |
| 0117128L04 | 0117128L24 | 0117128L31 | 0117128LM1 | 0117128LM2 | 128 | 200 | 2 | 25 |
| - | 0117192L24 | - | - | - | 192 | 300 | 2 | 25 |
| - | 0117320L24 | - | - | - | 320 | 400 | 3 | 25 |
| - | 0117416L24 | - | - | - | 416 | 500 | 3 | 25 |

0139 / 0140 **LINEAR** ALUMINIUM Designer: Viefe Studio

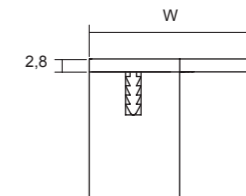
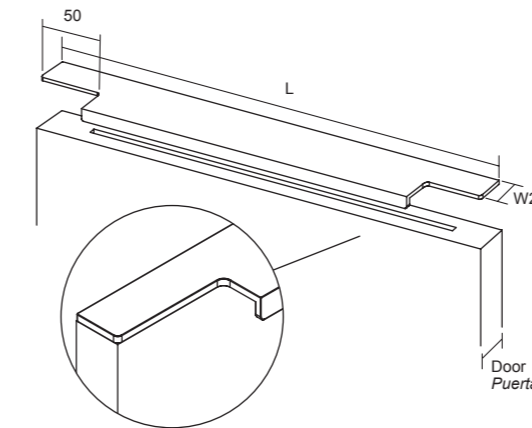

| L24 | L30 | L | W (d19) | W2 | ☐ | Door Puerta | L24 | L30 | L | W (d20,5) | W2 | ☐ | Door Puerta |
|--------------------------------|----------------------------------|------|---------|------|----|-------------|--------------------------------|----------------------------------|------|-----------|----|----|-------------|
| Stain. steel look Inox look | Brushed black Negro cepillado | | | | | | Stain. steel look Inox look | Brushed black Negro cepillado | | | | | |
| 0139147L24 | 0139147L30 | 147 | 37 | 19,8 | 15 | 19mm | 0140147L24 | 0140147L30 | 147 | 38,5 | 21 | 15 | 20,5mm |
| 0139197L24 | 0139197L30 | 197 | 37 | 19,8 | 15 | 19mm | 0140197L24 | 0140197L30 | 197 | 38,5 | 21 | 15 | 20,5mm |
| 0139247L24 | 0139247L30 | 247 | 37 | 19,8 | 15 | 19mm | 0140247L24 | 0140247L30 | 247 | 38,5 | 21 | 15 | 20,5mm |
| 0139297L24 | 0139297L30 | 297 | 37 | 19,8 | 15 | 19mm | 0140297L24 | 0140297L30 | 297 | 38,5 | 21 | 15 | 20,5mm |
| 0139347L24 | 0139347L30 | 347 | 37 | 19,8 | 15 | 19mm | 0140347L24 | 0140347L30 | 347 | 38,5 | 21 | 15 | 20,5mm |
| 0139397L24 | 0139397L30 | 397 | 37 | 19,8 | 15 | 19mm | 0140397L24 | 0140397L30 | 397 | 38,5 | 21 | 15 | 20,5mm |
| 0139447L24 | 0139447L30 | 447 | 37 | 19,8 | 10 | 19mm | 0140447L24 | 0140447L30 | 447 | 38,5 | 21 | 10 | 20,5mm |
| 0139497L24 | 0139497L30 | 497 | 37 | 19,8 | 10 | 19mm | 0140497L24 | 0140497L30 | 497 | 38,5 | 21 | 10 | 20,5mm |
| 0139597L24 | 0139597L30 | 597 | 37 | 19,8 | 10 | 19mm | 0140597L24 | 0140597L30 | 597 | 38,5 | 21 | 10 | 20,5mm |
| 0139697L24 | 0139697L30 | 697 | 37 | 19,8 | 10 | 19mm | 0140697L24 | 0140697L30 | 697 | 38,5 | 21 | 10 | 20,5mm |
| 0139797L24 | 0139797L30 | 797 | 37 | 19,8 | 10 | 19mm | 0140797L24 | 0140797L30 | 797 | 38,5 | 21 | 10 | 20,5mm |
| 0139897L24 | 0139897L30 | 897 | 37 | 19,8 | 5 | 19mm | 0140897L24 | 0140897L30 | 897 | 38,5 | 21 | 5 | 20,5mm |
| 0139997L24 | 0139997L30 | 997 | 37 | 19,8 | 5 | 19mm | 0140997L24 | 0140997L30 | 997 | 38,5 | 21 | 5 | 20,5mm |
| 01391197L24 | 01391197L30 | 1197 | 37 | 19,8 | 5 | 19mm | 01401197L24 | 01401197L30 | 1197 | 38,5 | 21 | 5 | 20,5mm |

0434

VECTOR

ALUMINIUM

Designer: Viefe Studio

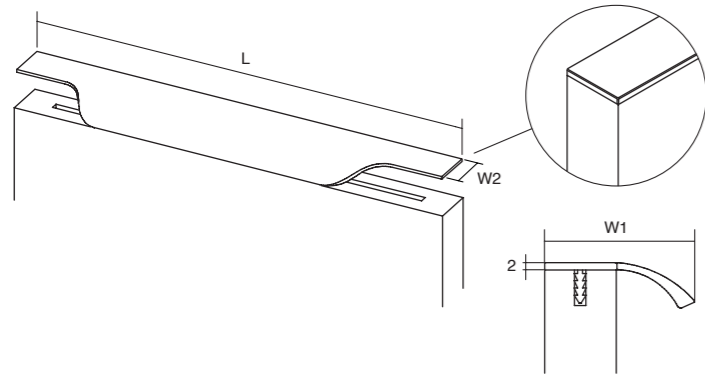

| L24 | L30 | L31 | L | W1 | W2 | Door |
|----------------------------|----------------------------------|--------------------------------|------|----|------|--------|
| S. steel look Inox look | Brushed black Negro cepillado | Brushed grey Gris cepillado | | | | Puerta |
| 0434147L24 | 0434147L30 | 0434147L31 | 147 | 41 | 19.8 | 15 19 |
| 0434197L24 | 0434197L30 | 0434197L31 | 197 | 41 | 19.8 | 15 19 |
| 0434247L24 | 0434247L30 | 0434247L31 | 247 | 41 | 19.8 | 15 19 |
| 0434297L24 | 0434297L30 | 0434297L31 | 297 | 41 | 19.8 | 15 19 |
| 0434347L24 | 0434347L30 | 0434347L31 | 347 | 41 | 19.8 | 15 19 |
| 0434397L24 | 0434397L30 | 0434397L31 | 397 | 41 | 19.8 | 15 19 |
| 0434447L24 | 0434447L30 | 0434447L31 | 447 | 41 | 19.8 | 10 19 |
| 0434497L24 | 0434497L30 | 0434497L31 | 497 | 41 | 19.8 | 10 19 |
| 0434597L24 | 0434597L30 | 0434597L31 | 597 | 41 | 19.8 | 10 19 |
| 0434697L24 | 0434697L30 | 0434697L31 | 697 | 41 | 19.8 | 10 19 |
| 0434797L24 | 0434797L30 | 0434797L31 | 797 | 41 | 19.8 | 10 19 |
| 0434897L24 | 0434897L30 | 0434897L31 | 897 | 41 | 19.8 | 5 19 |
| 0434997L24 | 0434997L30 | 0434997L31 | 997 | 41 | 19.8 | 5 19 |
| 04341197L24 | 04341197L30 | 04341197L31 | 1197 | 41 | 19.8 | 5 19 |

0250 / 0251

FORMA

ALUMINIUM

Designer: 2J Design

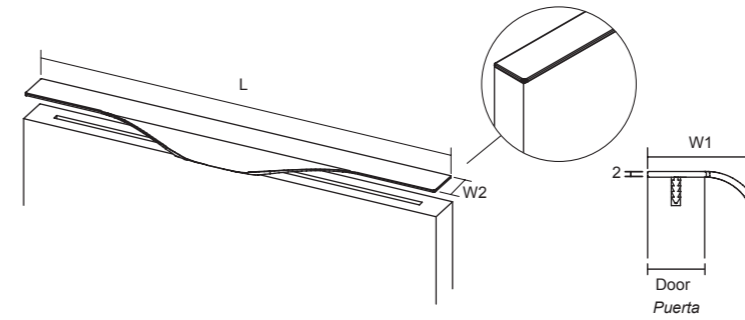

| L24 | L | W1 | W2 | Door | L24 | L | W1 | W2 | Door |
|--------------------------------|------|----|------|--------|--------------------------------|------|----|----|---------|
| Stain. steel look Inox look | | | | Puerta | Stain. steel look Inox look | | | | Puerta |
| 0250147L24 | 147 | 38 | 19,8 | 15 19 | 0251147L24 | 147 | 40 | 21 | 15 20,5 |
| 0250197L24 | 197 | 38 | 19,8 | 15 19 | 0251197L24 | 197 | 40 | 21 | 15 20,5 |
| 0250247L24 | 247 | 38 | 19,8 | 15 19 | 0251247L24 | 247 | 40 | 21 | 15 20,5 |
| 0250297L24 | 297 | 38 | 19,8 | 15 19 | 0251297L24 | 297 | 40 | 21 | 15 20,5 |
| 0250347L24 | 347 | 38 | 19,8 | 15 19 | 0251347L24 | 347 | 40 | 21 | 15 20,5 |
| 0250397L24 | 397 | 38 | 19,8 | 15 19 | 0251397L24 | 397 | 40 | 21 | 15 20,5 |
| 0250447L24 | 447 | 38 | 19,8 | 10 19 | 0251447L24 | 447 | 40 | 21 | 10 20,5 |
| 0250497L24 | 497 | 38 | 19,8 | 10 19 | 0251497L24 | 497 | 40 | 21 | 10 20,5 |
| 0250597L24 | 597 | 38 | 19,8 | 10 19 | 0251597L24 | 597 | 40 | 21 | 10 20,5 |
| 0250697L24 | 697 | 38 | 19,8 | 10 19 | 0251697L24 | 697 | 40 | 21 | 10 20,5 |
| 0250797L24 | 797 | 38 | 19,8 | 10 19 | 0251797L24 | 797 | 40 | 21 | 10 20,5 |
| 0250897L24 | 897 | 38 | 19,8 | 5 19 | 0251897L24 | 897 | 40 | 21 | 5 20,5 |
| 0250997L24 | 997 | 38 | 19,8 | 5 19 | 0251997L24 | 997 | 40 | 21 | 5 20,5 |
| 02501197L24 | 1197 | 38 | 19,8 | 5 19 | 02511197L24 | 1197 | 40 | 21 | 5 20,5 |

0254/0255

NOMA

ALUMINIUM

Designer: 2J Design

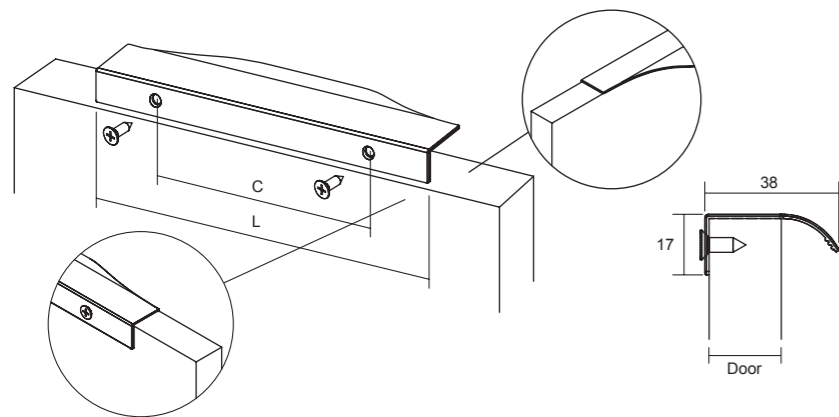

| L02 | L24 | L30 | L613 | L618 | C | L | ↓ | Door |
|-------------------------------------|-----------------------------------|----------------------------------|----------------------------------|--|-----|-----|------|--------|
| Anodized bright Anodizado brillo | Stainless steel look Inox look | Brushed black Negro cepillado | Antique bronze Bronce antiguo | Brushed brass cava Latón cava cepillado | | | | Puerta |
| 0254128L02 | 0254128L24 | 0254128L30 | 0254128L613 | 0254128L618 | 128 | 200 | 2 25 | 19 |
| 0254256L02 | 0254256L24 | 0254256L30 | 0254256L613 | 0254256L618 | 256 | 350 | 2 25 | 19 |
| - | 0255128L24 | - | - | - | 128 | 200 | 2 25 | 22 |
| - | 0255256L24 | - | - | - | 256 | 350 | 2 25 | 22 |

0334

BRIKK

ALUMINIUM

Designer: Alexis Vivet

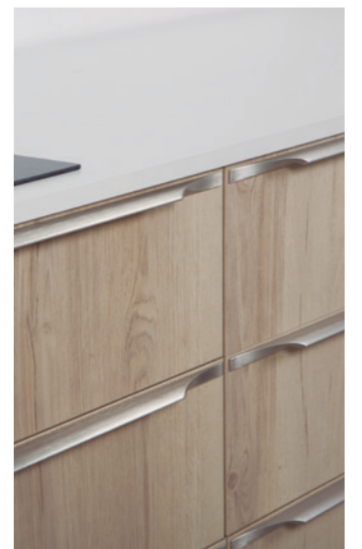
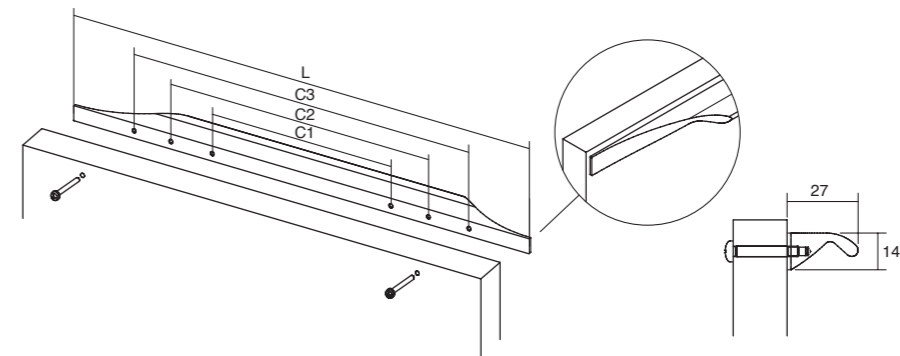

| L24 | L613 | C1 | C2 | C3 | L | ↓ | Door |
|-----------------------------------|----------------------------------|-----|-----|------|------|------|--------|
| Stainless steel look Inox look | Antique bronze Bronce antiguo | | | | | | Puerta |
| 0334140L24 | 0334140L613 | 32 | - | - | 140 | 2 15 | |
| 0334190L24 | - | 64 | - | - | 190 | 2 15 | |
| 0334240L24 | - | 96 | - | - | 240 | 2 15 | |
| 0334290L24 | 0334290L613 | 160 | - | - | 290 | 2 15 | |
| 0334340L24 | - | 192 | - | - | 340 | 2 15 | |
| 0334390L24 | - | 128 | 260 | - | 390 | 4 15 | |
| 0334440L24 | - | 160 | 310 | - | 440 | 4 10 | |
| 0334490L24 | 0334490L613 | 192 | 360 | - | 490 | 4 10 | |
| 0334590L24 | - | 224 | 460 | - | 590 | 4 10 | |
| 0334690L24 | - | 256 | 560 | - | 690 | 4 10 | |
| 0334790L24 | - | 320 | 660 | - | 790 | 4 10 | |
| 0334890L24 | - | 384 | 760 | - | 890 | 4 5 | |
| 0334990L24 | - | 320 | 640 | 860 | 990 | 6 5 | |
| 03341190L24 | 03341190L613 | 320 | 832 | 1060 | 1190 | 6 5 | |

0380 **STEEP** ALUMINIUM Designer: Viefe Studio

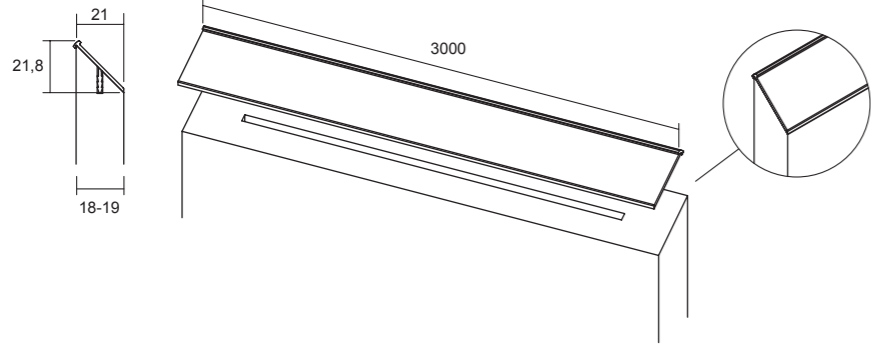

| L02 | L24 | LM2 | |
|-------------------------------------|-----------------------------------|--------------------------|------|
| Anodized bright Anodizado brillo | Stainless steel look Inox look | Matt black Negro mate | 📦 |
| 03803000L02 | 03803000L24 | 03803000LM2 | 15 * |

* Three metre profiles are delivered according to the units of the original packaging and cannot be sold separately.
Las barras de tres metros se sirven según las cantidades del embalaje original y no se pueden servir por separado.

0219 **ARROW** ZAMAK Designer: 2J Design

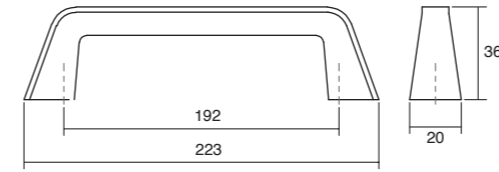

| Z23 | |
|------------------------------------|------|
| Brushed nickel Níquel cepillado | 📦 |
| 0219192Z23 | 2 25 |

0343 **GRADA** ALUMINIUM Designer: Viefe Studio

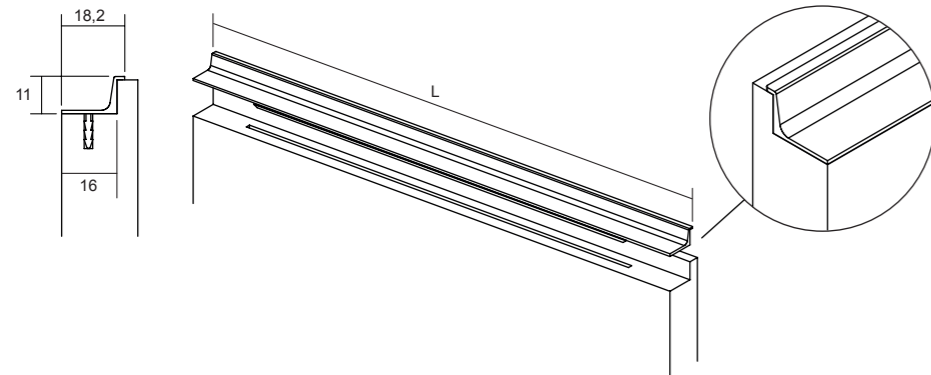

| L02 | L04 | L24 | LM1 | LM2 | L | 📦 |
|-------------------------------------|---------------------------------|-----------------------------------|---------------------------|--------------------------|------|-----|
| Anodized bright Anodizado brillo | Anodized matt Anodizado mate | Stainless steel look Inox look | Matt white Blanco mate | Matt black Negro mate | | |
| - | 0343147L04 | 0343147L24 | 0343147LM1 | 0343147LM2 | 147 | 15 |
| - | 0343197L04 | 0343197L24 | 0343197LM1 | 0343197LM2 | 197 | 15 |
| - | 0343247L04 | 0343247L24 | 0343247LM1 | 0343247LM2 | 247 | 15 |
| - | 0343297L04 | 0343297L24 | 0343297LM1 | 0343297LM2 | 297 | 15 |
| - | 0343347L04 | 0343347L24 | 0343347LM1 | 0343347LM2 | 347 | 15 |
| - | 0343397L04 | 0343397L24 | 0343397LM1 | 0343397LM2 | 397 | 15 |
| - | 0343447L04 | 0343447L24 | 0343447LM1 | 0343447LM2 | 447 | 10 |
| - | 0343497L04 | 0343497L24 | 0343497LM1 | 0343497LM2 | 497 | 10 |
| - | 0343597L04 | 0343597L24 | 0343597LM1 | 0343597LM2 | 597 | 10 |
| - | 0343697L04 | 0343697L24 | 0343697LM1 | 0343697LM2 | 697 | 10 |
| - | 0343797L04 | 0343797L24 | 0343797LM1 | 0343797LM2 | 797 | 10 |
| - | 0343897L04 | 0343897L24 | 0343897LM1 | 0343897LM2 | 897 | 5 |
| - | 0343997L04 | 0343997L24 | 0343997LM1 | 0343997LM2 | 997 | 5 |
| - | 03431197L04 | 03431197L24 | 03431197LM1 | 03431197LM2 | 1197 | 5 |
| 03433000L02 | 03433000L04 | 03433000L24 | 03433000LM1 | 03433000LM2 | 3000 | 15* |

* Three metre profiles are delivered according to the units of the original packaging and cannot be sold separately.
Las barras de tres metros se sirven según las cantidades del embalaje original y no se pueden servir por separado.

0410 **BUTTON** ZAMAK Designer: Alexis Vivet

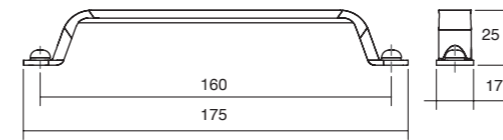

| Z610 | Z614 | ZM2 | |
|------------------|--------------------------------|--------------------------|------|
| Pewter Peltre | Antique Brass Latón antiguo | Matt black Negro mate | 📦 |
| 0410160Z610 | 0410160Z614 | 0410160ZM2 | 2 25 |

0393 **DUKE** ZAMAK Designer: Viefe Studio

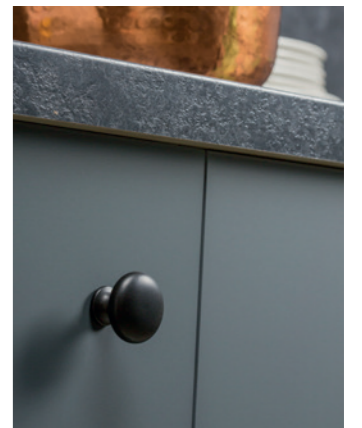
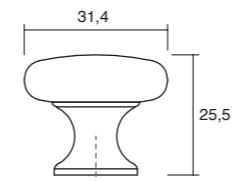

| Z01 | Z23 | Z26 | Z27 | Z66 | Z610 | Z612 | Z614 | ZM1 | ZM2 | |
|-----------------------------|----------------------------------|-----------------------------------|----------------------------------|---------------------------------|------------------|---------------------------------|--------------------------------|---------------------------|--------------------------|------|
| Pol. chrome Cromo brillo | Brushed nickel Níquel cepill. | Brushed copper Cobre cepillado | Brushed brass Latón cepillado | Antique copper Cobre antiguo | Pewter Peltre | Antique silver Plata antigua | Antique Brass Latón antiguo | Matt white Blanco mate | Matt black Negro mate | 📦 |
| 0393031Z01 | 0393031Z23 | 0393031Z26 | 0393031Z27 | 0393031Z66 | 0393031Z610 | 0393031Z612 | 0393031Z614 | 0393031ZM1 | 0393031ZM2 | 1 25 |

0226 **REDO** ZAMAK Designer: 2J Design

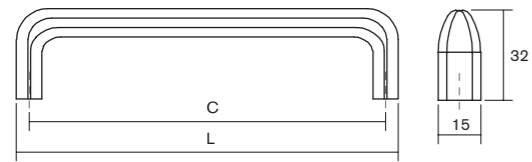

| Z23 | Z26 | Z610 | Z614 | C | L | ↓ | ☐ |
|-------------------------|------------------------|---------------|----------------------|-----|-----|---|----|
| Brushed nickel | Brushed copper | Pewter | Antique Brass | | | | |
| <i>Níquel cepillado</i> | <i>Cobre cepillado</i> | <i>Peltre</i> | <i>Latón antiguo</i> | | | | |
| 0226128Z23 | 0226128Z26 | 0226128Z610 | 0226128Z614 | 128 | 137 | 2 | 25 |
| 0226192Z23 | 0226192Z26 | 0226192Z610 | 0226192Z614 | 192 | 201 | 2 | 25 |

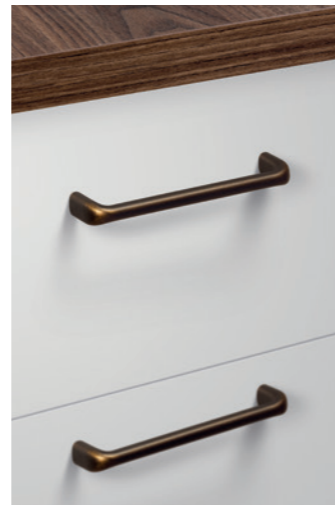

0390 **PETRA** ZAMAK Designer: Viefe Studio

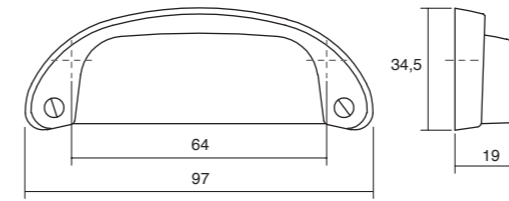

| Z66 | Z612 | ZM2 | ↓ | ☐ |
|----------------------|----------------------|-------------------|---|----|
| Antique copper | Antique silver | Matt black | | |
| <i>Cobre antiguo</i> | <i>Plata antigua</i> | <i>Negro mate</i> | | |
| 0390064Z66 | 0390064Z612 | 0390064ZM2 | 2 | 25 |

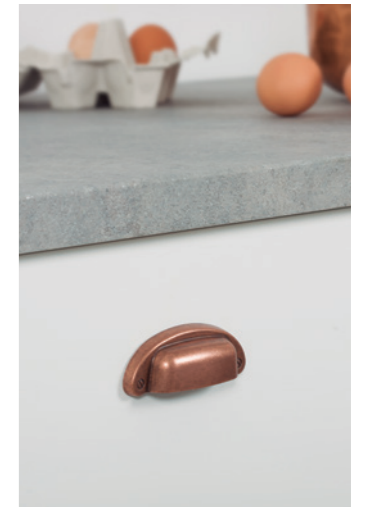

0405 **RAVIOLO** ZAMAK Designer: Balutto Associati

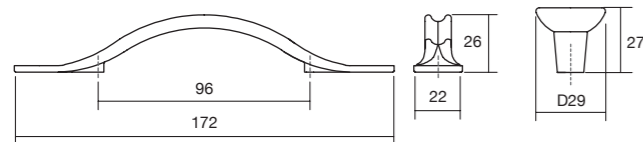

| Z610 | Z614 | ↓ | ☐ |
|---------------|----------------------|---|----|
| Pewter | Antique Brass | | |
| <i>Peltre</i> | <i>Latón antiguo</i> | | |
| 0405029Z610 | 0405029Z614 | 1 | 25 |
| 0405096Z610 | 0405096Z614 | 2 | 25 |



0391 **AURA** ZAMAK Designer: Viefe Studio

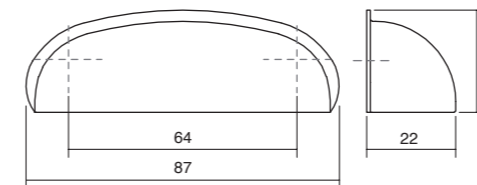

| Z66 | Z612 | ↓ | ☐ |
|----------------------|----------------------|---|----|
| Antique copper | Antique silver | | |
| <i>Cobre antiguo</i> | <i>Plata antigua</i> | | |
| 0391064Z66 | 0391064Z612 | 2 | 25 |



0394 **AVA** ZAMAK Designer: Viefe Studio

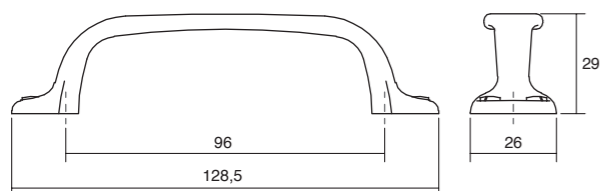

| Z610 | Z614 | ↓ | ☐ |
|---------------|----------------------|---|----|
| Pewter | Antique Brass | | |
| <i>Peltre</i> | <i>Latón antiguo</i> | | |
| 0394096Z610 | 0394096Z614 | 2 | 25 |



0392 **ORION** ZAMAK Designer: Viefe Studio

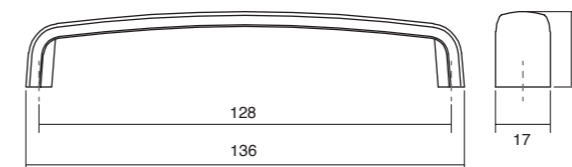

| Z66 | Z612 | ↓ | ☐ |
|----------------------|----------------------|---|----|
| Antique copper | Antique silver | | |
| <i>Cobre antiguo</i> | <i>Plata antigua</i> | | |
| 0392128Z66 | 0392128Z612 | 2 | 25 |



0404 **FLEXA** LEATHER + ZAMAK Designer: Balutto Associati

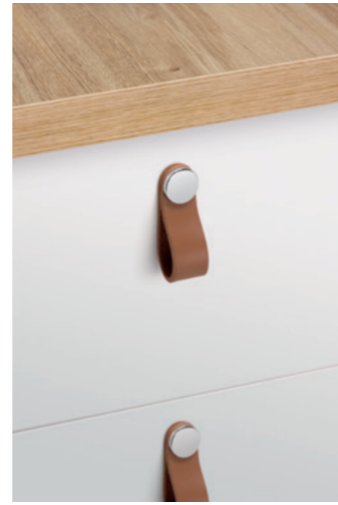
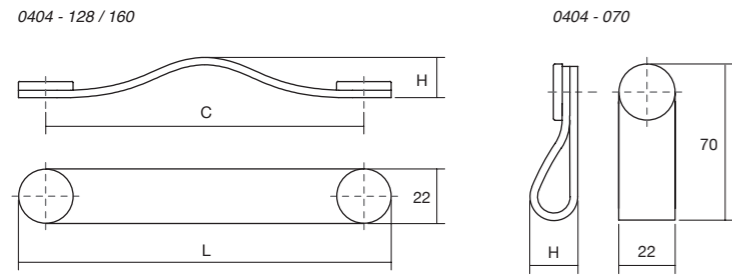

| | P26 Beige / Beige | P36 Brown / Marrón | P99 Black / Negro | C | L | H | ↓ | ☐ |
|------------------------------------|----------------------|-----------------------|----------------------|-----|-----|----|---|----|
| Z01 Polished chrome / Cromo brillo | 0404070P2601 | 0404070P3601 | 0404070P9901 | - | 70 | 24 | 1 | 25 |
| Z01 Polished chrome / Cromo brillo | 0404128P2601 | 0404128P3601 | 0404128P9901 | 128 | 150 | 25 | 2 | 25 |
| Z01 Polished chrome / Cromo brillo | 0404160P2601 | 0404160P3601 | 0404160P9901 | 160 | 182 | 27 | 2 | 25 |
| Z610 Pewter / Peltre | 0404070P2610 | 0404070P3610 | 0404070P9910 | - | 70 | 24 | 1 | 25 |
| Z610 Pewter / Peltre | 0404128P2610 | 0404128P3610 | 0404128P9910 | 128 | 150 | 25 | 2 | 25 |
| Z610 Pewter / Peltre | 0404160P2610 | 0404160P3610 | 0404160P9910 | 160 | 182 | 27 | 2 | 25 |
| ZM2 Black / Negro | 0404070P26M2 | 0404070P36M2 | 0404070P99M2 | - | 70 | 24 | 1 | 25 |
| ZM2 Black / Negro | 0404128P26M2 | 0404128P36M2 | 0404128P99M2 | 128 | 150 | 25 | 2 | 25 |
| ZM2 Black / Negro | 0404160P26M2 | 0404160P36M2 | 0404160P99M2 | 160 | 182 | 27 | 2 | 25 |
| Z27 Brass / Latón | 0404070P2627 | 0404070P3627 | 0404070P9927 | - | 70 | 24 | 1 | 25 |
| Z27 Brass / Latón | 0404128P2627 | 0404128P3627 | 0404128P9927 | 128 | 150 | 25 | 2 | 25 |
| Z27 Brass / Latón | 0404160P2627 | 0404160P3627 | 0404160P9927 | 160 | 182 | 27 | 2 | 25 |

0340 **BARCCO** WOOD Designer: Alexis Vivet

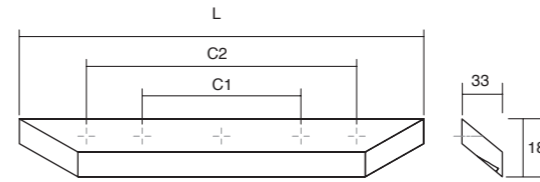

| W18 Ash Fresno | W19 Walnut Nogal | W00 Beech raw Haya crudo | C1 | C2 | L | ↓ | ☐ |
|----------------------|------------------------|--------------------------------|-----|-----|-----|---|----|
| 0340200W18 | 0340200W19 | 0340200W00 | 160 | - | 200 | 3 | 25 |
| 0340400W18 | 0340400W19 | 0340400W00 | 320 | - | 400 | 3 | 25 |
| 0340600W18 | 0340600W19 | 0340600W00 | 320 | 480 | 600 | 4 | 25 |



0165 **CALIN** WOOD Designer: Viefe Studio

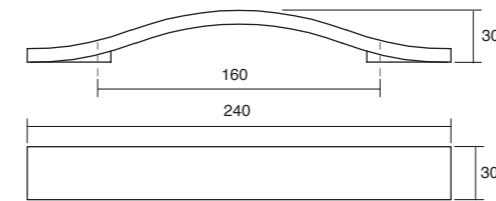

| W00 Raw brushed Crudo cepillado | W02 White brushed Blanco cepillado | W08 Brown brushed Marrón cepillado | W09 Black brushed Negro cepillado | ↓ | ☐ |
|---------------------------------------|--|--|---|---|----|
| 0165160W00 | 0165160W02 | 0165160W08 | 0165160W09 | 2 | 25 |



0239 **ARA W** ALUMINIUM + WOOD Designer: 2J Design

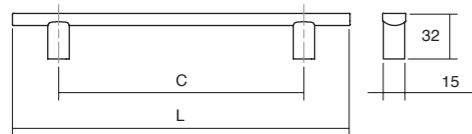

| N2416 (L24+W16) Stainless steel look + Oak Inox look + Roble | N2417 (L24+W17) Stainless steel look + Walnut Inox look + Nogal | C | L | ↓ | ☐ |
|--|---|-----|-----|---|----|
| 0239160N2416 | 0239160N2417 | 160 | 220 | 2 | 25 |
| 0239224N2416 | 0239224N2417 | 224 | 284 | 2 | 25 |



0166 **ECHO** WOOD Designer: Viefe Studio

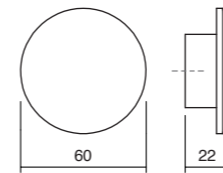

| W00 Raw brushed Crudo cepillado | W02 White brushed Blanco cepillado | W08 Brown brushed Marrón cepillado | W09 Black brushed Negro cepillado | ↓ | ☐ |
|---------------------------------------|--|--|---|---|----|
| 0166060W00 | 0166060W02 | 0166060W08 | 0166060W09 | 1 | 25 |



0374 **BALL**

ZAMAK

Designer: Alexis Vivet

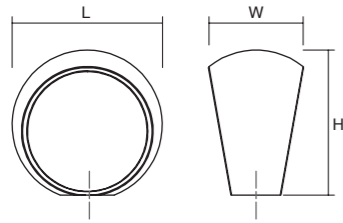

| Z01 | Z23 | Z27 | L | W | H | ↓ | ☐ |
|--|---|---|------|------|------|---|----|
| Polished chrome <i>Cromo brillo</i> | Brushed nickel <i>Níquel cepillado</i> | Brushed brass <i>Latón cepillado</i> | | | | | |
| 0374024Z01 | 0374024Z23 | 0374024Z27 | 23,3 | 14,8 | 22,8 | 1 | 25 |
| 0374029Z01 | 0374029Z23 | 0374029Z27 | 29,5 | 18,3 | 28,8 | 1 | 25 |

0369 **RITTA**

ALUMINIUM

Designer: Teruel & Paré

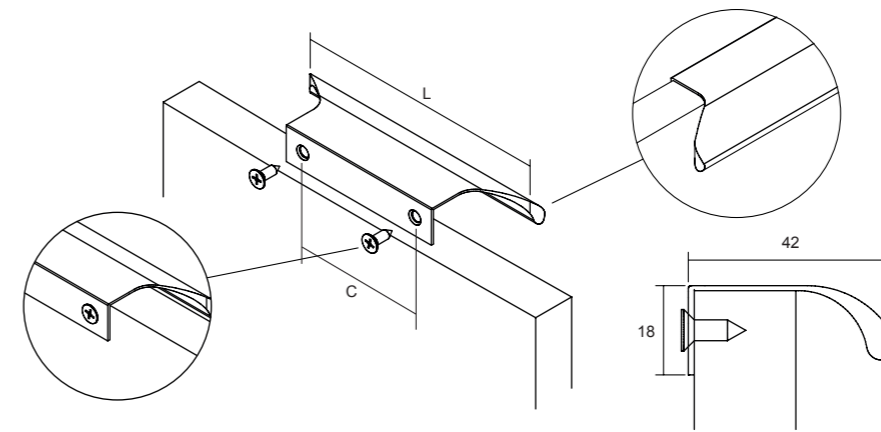

| L01 | L09 | L24 | C | L | ↓ | ☐ |
|--|---------------------------------|--|-----|-----|---|----|
| Polished chrome <i>Cromo brillo</i> | Matt black <i>Negro mate</i> | Stainless steel look <i>Inox look</i> | | | | |
| 0369064L01 | 0369064L09 | 0369064L24 | 64 | 130 | 2 | 25 |
| 0369128L01 | 0369128L09 | 0369128L24 | 128 | 260 | 2 | 25 |

0243 **LOW ST**

ZAMAK

Designer: Viefe Studio

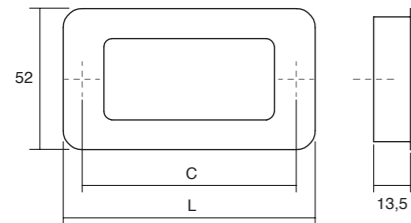

| Z23 | C | L | ↓ | ☐ |
|---|-----|-----|---|----|
| Brushed nickel <i>Níquel cepillado</i> | | | | |
| 0243064Z23ST | 64 | 78 | 2 | 25 |
| 0243192Z23ST | 192 | 206 | 2 | 25 |

With backplate / Con placa posterior

0091 **RASO**

ZAMAK

Designer: Viefe Studio

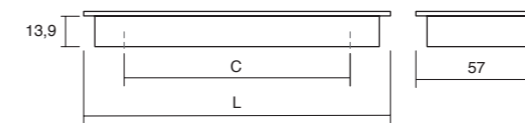

| Z23 | C | L | ↓ | ☐ |
|---|-----|-------|---|----|
| Brushed nickel <i>Níquel cepillado</i> | | | | |
| 0091032Z23 | 32 | 70 | 2 | 25 |
| 0091108Z23 | 108 | 152,5 | 2 | 25 |

0281 **FLAT**

ZAMAK

Designer: Oriol Barri

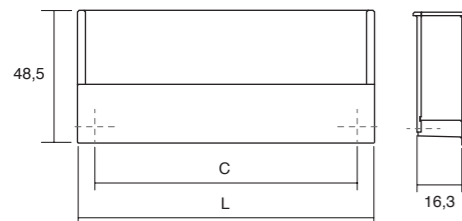

| Z23 | C | L | ↓ | ☐ |
|---|-----|-------|---|----|
| Brushed nickel <i>Níquel cepillado</i> | | | | |
| 0281160Z23 | 160 | 174,8 | 2 | 25 |

0376 **BOXX**

ZAMAK

Designer: Alexis Vivet

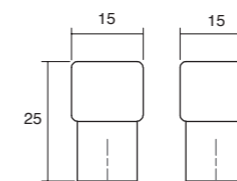

| Z01 | Z11 | Z23 | ZM2 | ↓ | ☐ |
|--|----------------------------------|---|---------------------------------|---|----|
| Polished chrome <i>Cromo brillo</i> | Matt chrome <i>Cromo mate</i> | Brushed nickel <i>Níquel cepillado</i> | Matt black <i>Negro mate</i> | | |
| 0376012Z01 | 0376012Z11 | 0376012Z23 | 0376012ZM2 | 1 | 25 |

0064 **KOMBI** STAINLESS STEEL Designer: Viefe Studio

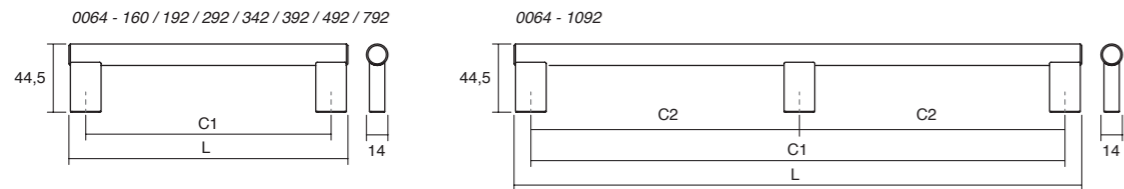

S25
Brushed stainless steel
Inox cepillado

| | C1 | C2 | L | ↓ | ☐ |
|-------------|------|-----|------|---|----|
| 0064160S25 | 160 | - | 182 | 2 | 25 |
| 0064192S25 | 192 | - | 214 | 2 | 25 |
| 0064292S25 | 292 | - | 314 | 2 | 25 |
| 0064342S25 | 342 | - | 364 | 2 | 25 |
| 0064392S25 | 392 | - | 414 | 2 | 25 |
| 0064492S25 | 492 | - | 514 | 2 | 25 |
| 0064792S25 | 792 | - | 814 | 2 | 10 |
| 00641092S25 | 1092 | 546 | 1114 | 3 | 10 |



6005 **FONDA** ALUMINIUM Designer: Viefe Studio

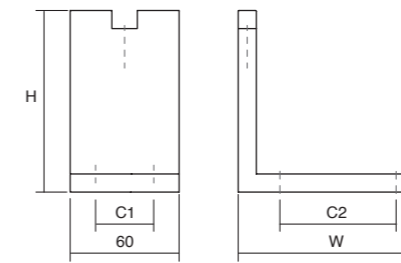

| L01 | L24 | L29 | L30 | C1 | C2 | W | H | ↓ | ☐ |
|--|--|---|---|----|----|-----|-----|---|----|
| Polished chrome <i>Cromo brillo</i> | Stainless steel look <i>Inox look</i> | Brushed dark brass <i>Latón oscuro cepillado</i> | Brushed black <i>Negro cepillado</i> | | | | | | |
| 6005100L01 | 6005100L24 | 6005100L29 | 6005100L30 | 32 | 44 | 80 | 100 | 4 | 24 |
| 6005150L01 | 6005150L24 | 6005150L29 | 6005150L30 | 32 | 44 | 80 | 150 | 4 | 24 |
| 6005200L01 | 6005200L24 | 6005200L29 | 6005200L30 | 32 | 64 | 100 | 200 | 4 | 24 |



0312 **ARKO** ALUMINIUM Designer: Viefe Studio

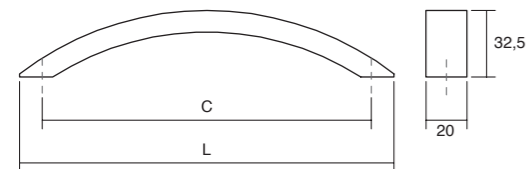

L24
Stain. steel look
Inox look

| | C | L | ↓ | ☐ |
|------------|-----|-----|---|----|
| 0312160L24 | 160 | 186 | 2 | 25 |
| 0312192L24 | 192 | 218 | 2 | 25 |
| 0312256L24 | 256 | 292 | 2 | 25 |



0035 **ACER** STAINLESS STEEL Designer: 2J Design

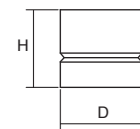

S25
Brushed stain. steel
Inox cepillado

| | D | H | ↓ | ☐ |
|------------|----|----|---|----|
| 0035018S25 | 18 | 23 | 1 | 25 |
| 0035023S25 | 23 | 25 | 1 | 25 |
| 0035028S25 | 28 | 27 | 1 | 25 |



Finishes

ZAMAK

Glossy Brillante



Grey Gris



Brass Latón



Black Negro



Color Color



White Blanco

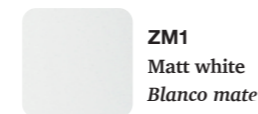

Copper Cobre



Inox look Look inox



Vintage Vintage



ALUMINIUM

Glossy Brillante

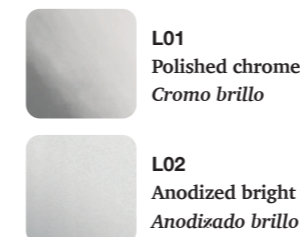

Grey Gris



White Blanco



Brass Latón



Black Negro

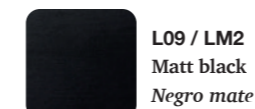

Color Color



Stainless steel look Look inox

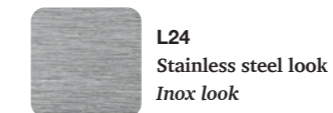

Vintage Vintage



STAINLESS STEEL



WOOD



LEATHER



IMPORTANT NOTE:

The finishes that you see represented in this section are a digital simulation of the real finishes and in no way can they be used as a reference for physical comparisons. The aim of this index is to guide and inform the user about the finishes we work with. The finishes of all our models are defined exactly as is indicated in the catalogue and therefore are in no way characteristics that can be personalized.

NOTA IMPORTANTE:

Los acabados representados en esta sección son una simulación digital de los acabados reales y en ningún caso se pueden utilizar como referencia para comparativas físicas. Este índice se debe utilizar únicamente como orientación para conocer los acabados con los que trabaja Viefé. Todos los diseños de Viefé tienen sus acabados definidos tal como indica el catálogo y, por lo tanto, no es una característica personalizable en ningún caso.

NOTA IMPORTANT:

Els acabats representats en aquesta secció són una simulació digital dels acabats reals i en cap cas es poden utilitzar com a referència per a comparatives físiques. Aquest índex s'ha d'utilitzar únicament com a orientació per conèixer els acabats amb els que treballa Viefé. Tots els dissenys de Viefé tenen els seus acabats definits tal com indica el catàleg i per tant no és una característica personalitzable en cap cas.

| Number | Model | Product pag | Tech info pag |
|--------------------|------------------------|-------------|---------------|
| 0035 | ACER | 283 | 338 |
| 0077 | ANGLE | 146 - 149 | 323 |
| 0239 | ARA W | 272 - 273 | 334 |
| 0206 | ARCH | 282 | 323 |
| 0312 | ARKO | 281 | 338 |
| 0583 | ARPA | 108 - 113 | 307 |
| 0588 | ARPA PLATE | 104 - 107 | 306 |
| 0219 | ARROW | 279 | 331 |
| 0391 | AURA | 269 | 333 |
| 0394 | AVA | 266 | 332 |
| 0374 | BALL | 277 | 336 |
| 0340 | BARCCO | 274 - 275 | 335 |
| 0496 | BAU | 152 - 153 | 308 |
| 0447 | BELLA | 208 - 209 | 318 |
| 0590 | BELT | 66 - 69 | 297 |
| 0489 | BOL | 182 - 183 | 311 |
| 0376 | BOXX | 280 | 337 |
| 0452 | BRAVE | 232 - 233 | 324 |
| 0334 | BRIKK | 250 - 251 | 329 |
| 0410 | BUTTON | 258 - 259 | 331 |
| 0165 | CALIN | 276 | 335 |
| 0235 | CLOS | 220 - 221 | 320 |
| 0168 | COMO | 158 - 161 | 310 |
| 0538 | CONIC wood | 124 - 125 | 303 |
| 0538 | CONIC zamak | 126 - 127 | 304 |
| 0366 | CUBIC | 222 - 223 | 320 |
| 0117 | CURVE | 240 - 241 | 327 |
| 0322 | CUTT | 256 - 257 | 324 |
| 0497 | DIABOLO | 162 - 163 | 310 |
| 0053 | DINO | 252 - 253 | 326 |
| 0556 | DIPO | 138 - 139 | 304 |
| 0530 | DISC wood | 120 - 121 | 303 |
| 0530 | DISC zamak | 122 - 123 | 303 |
| 0393 | DUKE | 260 - 261 | 331 |
| 0659 / 0668 / 0670 | DUO BIG NEW! | 50 - 51 | 294 |
| 0658 | DUO MINI NEW! | 48 - 49 | 294 |
| 0166 | ECHO | 277 | 335 |
| 0614 | EQUIS | 96 - 97 | 302 |
| 0446 | ESTE | 206 - 207 | 314 |
| 0591 | ETO | 84 - 87 | 299 |
| 0451 | FELTRE | 230 - 231 | 318 |
| 0506 | FIRM | 114 - 119 | 315 |
| 0610 | FLAPP aluminium | 76 - 79 | 299 |
| 0613 | FLAPP wood | 80 - 83 | 300 |
| 0281 | FLAT | 278 | 336 |
| 0404 | FLEXA | 270 - 271 | 334 |
| 0495 | FLOID | 150 - 151 | 308 |
| 0542 | FOLD | 128 - 131 | 306 |
| 6005 | FONDA | 284 - 285 | 339 |
| 0250 / 0251 | FORMA | 249 | 329 |
| 0627 | FUSION NEW! | 18 - 21 | 288 |
| 0343 | GRADA | 246 - 247 | 330 |
| 0109 | GRAF | 202 - 203 | 318 |
| 0486 | GRAF BIG | 194 - 199 | 317 |
| 0430 | GRAF MINI | 200 - 201 | 317 |
| 0449 | HEXXA | 210 - 213 | 319 |
| 0094 | HIDE | 214 - 215 | 316 |
| 0127 | JEY | 154 - 157 | 309 |

| | | | |
|--------------------|------------------------|-----------|-----|
| 0163 | JEY2 | 156 - 157 | 309 |
| 0162 | KADO | 282 | 322 |
| 0064 | KOMBI | 283 | 338 |
| 0494 | LAND | 186 - 189 | 314 |
| 0635 | LIDD NEW! | 22 - 23 | 289 |
| 0139 / 0140 | LINEAR | 242 - 243 | 327 |
| 0459 | LINES | 204 - 205 | 315 |
| 0643 | LINKK NEW! | 26 - 29 | 290 |
| 0603 | LIPP NEW! | 34 - 35 | 291 |
| 0243 ST | LOW ST | 278 | 336 |
| 0536 | LUV | 56 - 57 | 295 |
| 0664 / 0665 / 0671 | LUV WOOD NEW! | 52 - 55 | 295 |
| 0629 / 0662 / 0663 | MOON NEW! | 44 - 47 | 293 |
| 0650 | MOULE NEW! | 32 - 33 | 291 |
| 0105 | NEST | 218 - 219 | 320 |
| 0373 | NICK | 254 - 255 | 322 |
| 0657 | NOBB NEW! | 40 - 43 | 293 |
| 0254 / 0255 | NOMA | 144 - 145 | 328 |
| 0507 | OBLONG | 184 - 185 | 313 |
| 0601 | OH! wood | 88 - 89 | 300 |
| 0601 | OH! zamak | 90 - 91 | 301 |
| 0648 | OMEGA NEW! | 30 - 31 | 290 |
| 0372 | ONA | 140 - 143 | 326 |
| 0392 | ORION | 268 | 333 |
| 0553 | OTO | 136 - 137 | 305 |
| 0444 | PEAK | 234 - 235 | 325 |
| 0516 | PENDANT | 190 - 193 | 316 |
| 0390 | PETRA | 267 | 333 |
| 0597 | PLIÉ | 70 - 71 | 298 |
| 0636 | POINT NEW! | 14 - 17 | 288 |
| 0638 | PRISM NEW! | 24 - 25 | 289 |
| 0604 | PRISMA | 98 - 99 | 301 |
| 0487 | PURA | 62 - 65 | 297 |
| 0616 | QUART big | 102 - 103 | 302 |
| 0608 | QUART mini | 100 - 101 | 302 |
| 0511 | RAIL | 170 - 173 | 312 |
| 0091 | RASO | 281 | 337 |
| 0405 | RAVILOLO | 264 - 265 | 332 |
| 0226 | REDO | 262 - 263 | 332 |
| 0528 | RILLE | 60 - 61 | 296 |
| 0621 | RILLE MINI NEW! | 58 - 59 | 296 |
| 0552 | RIM | 134 - 135 | 305 |
| 0645 | RISS MINI NEW! | 36 - 37 | 292 |
| 0655 | RISS BIG NEW! | 38 - 39 | 292 |
| 0369 | RITTA | 279 | 337 |
| 0241 | ROMA | 178 - 181 | 313 |
| 0499 | ROUND | 164 - 165 | 310 |
| 0195 | SENSE | 228 - 229 | 321 |
| 0301 | SENSE MINI | 226 - 227 | 321 |
| 0543 | SOFT | 132 - 133 | 304 |
| 0380 | STEEP | 248 | 330 |
| 0073 | TAP | 224 - 225 | 321 |
| 0056 | U | 174 - 177 | 312 |
| 0602 | VALLEY | 92 - 95 | 301 |
| 0375 | VANN | 236 - 239 | 325 |
| 0434 | VECTOR | 244 - 245 | 328 |
| 0119 | WAVE | 216 - 217 | 319 |
| 0518 | WAY | 166 - 169 | 311 |
| 0600 | WING | 72 - 75 | 298 |

viefe.com

**info@viefe.com
T +34 938584029**

**C/ Dels Traginers 2
Sant Pere de Torelló
08572 Barcelona
Spain**



20
24

Viefe®

**HANDLES & KNOBS
CATALOGUE**

 **viefe.com**